

# Radiotelescoop Dwingeloo, Een tweede jeugd



C.A. Muller Radio Astronomie Station

Jan van Muijlwijk  
PA3FXB





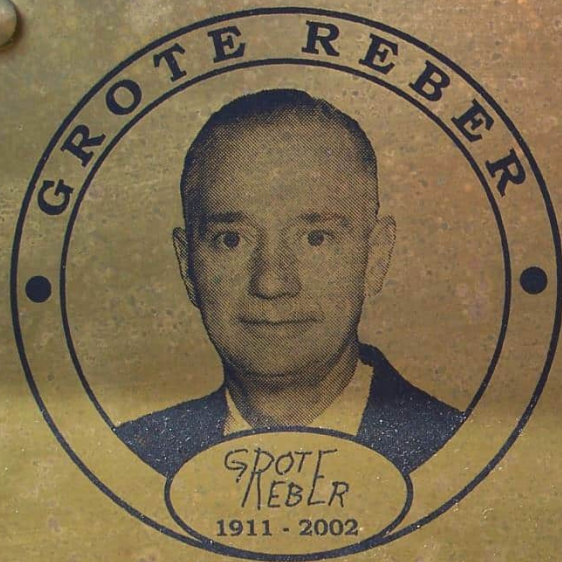

GROTE REBER  
1911 - 2002

THE FIRST RADIO ASTRONOMER AND THE  
FIRST ASTRONOMER TO CONSTRUCT A  
HIGH-ALTITUDE OBSERVATORY



TO COMMEMORATE THE LIFE AND WORK  
OF THE FIRST RADIO ASTRONOMER  
GROTE REBER (1911 - 2002).

HIS ASHES HAVE BEEN DISTRIBUTED TO MAJOR  
RADIO OBSERVATORIES AROUND THE WORLD.  
THE DWINGELOO TELESCOPE IS ONE OF THESE.





**[WWW.CAMRAS.NL](http://WWW.CAMRAS.NL)**



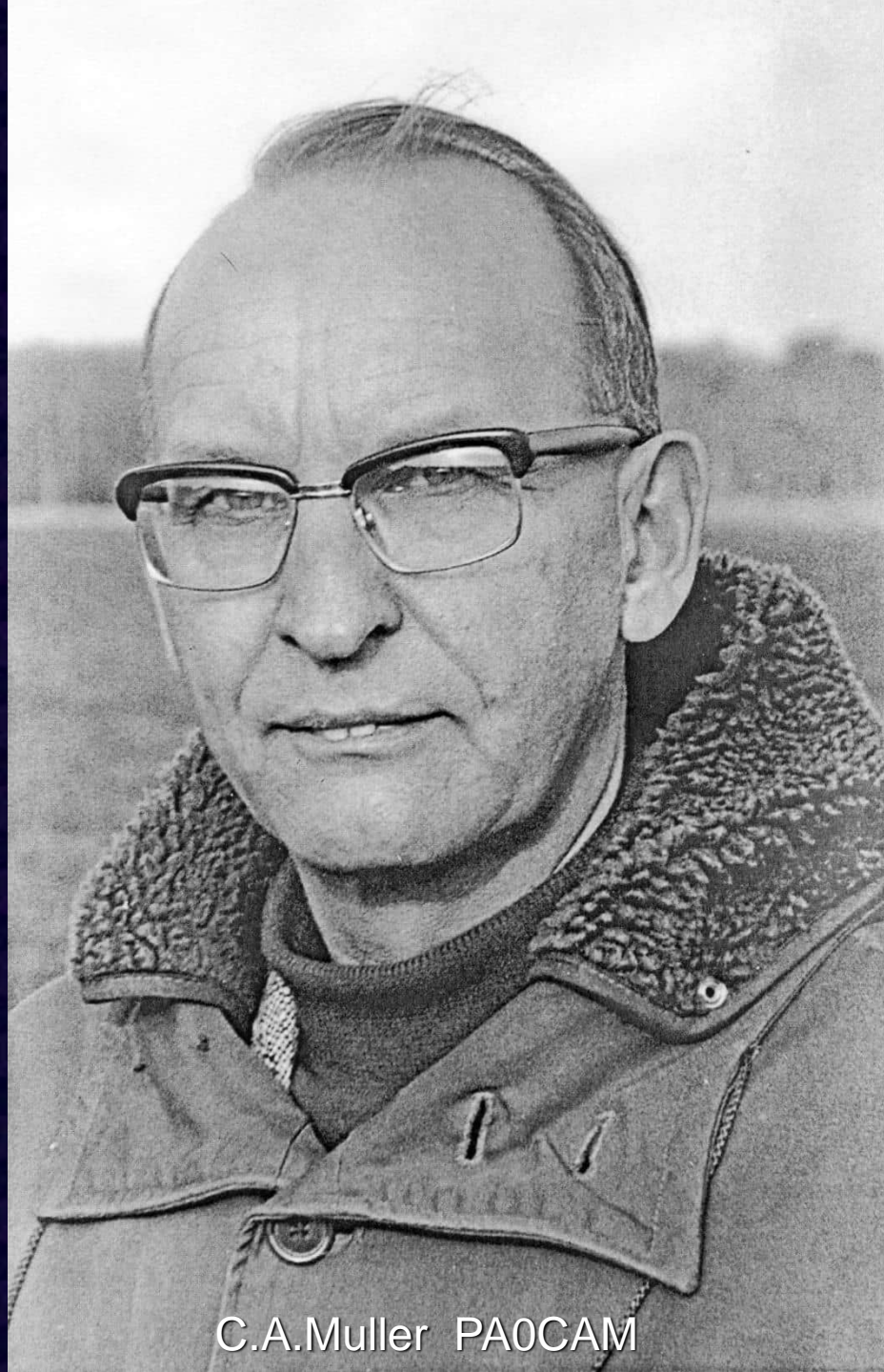

C.A.Muller PA0CAM











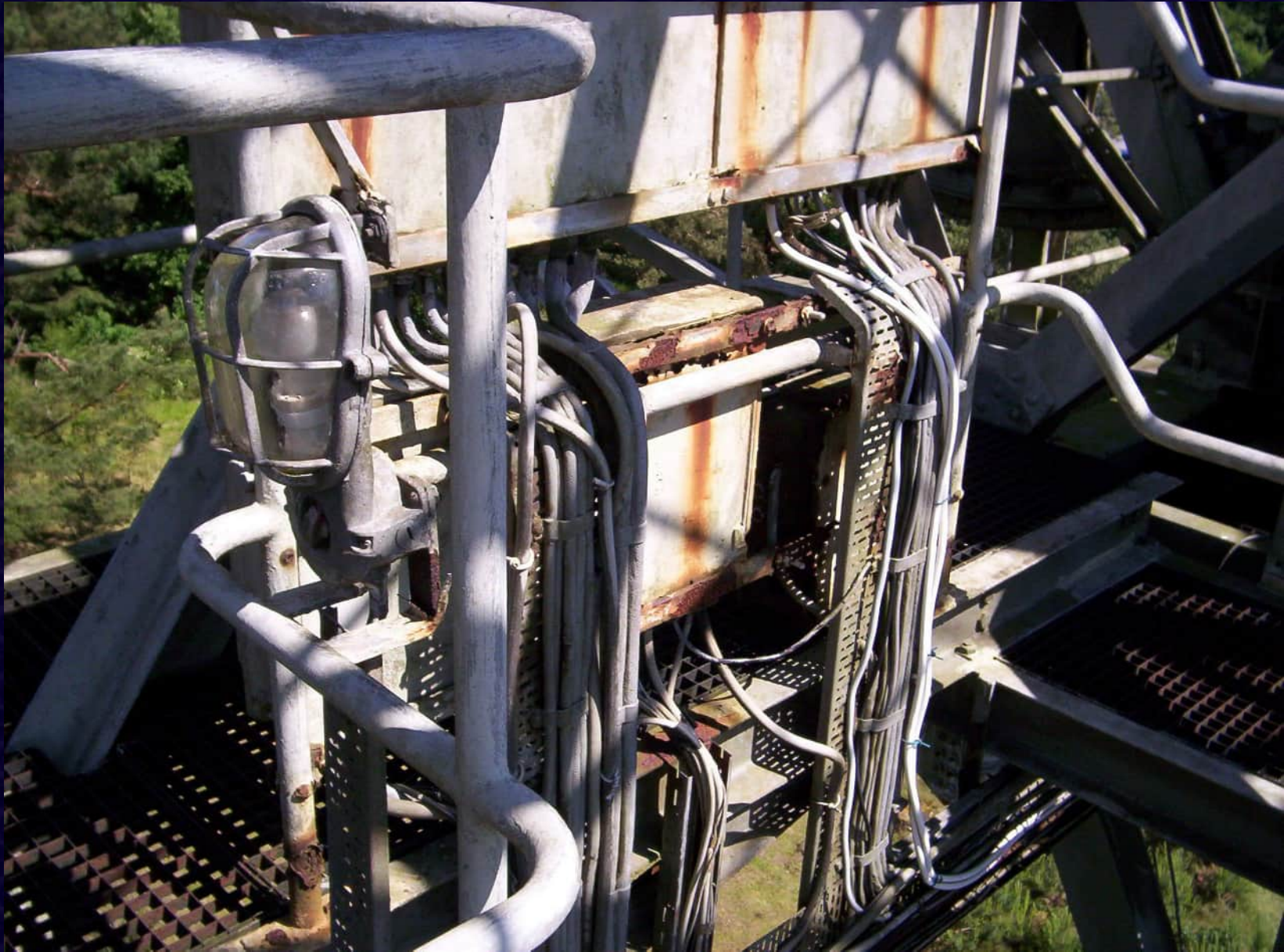



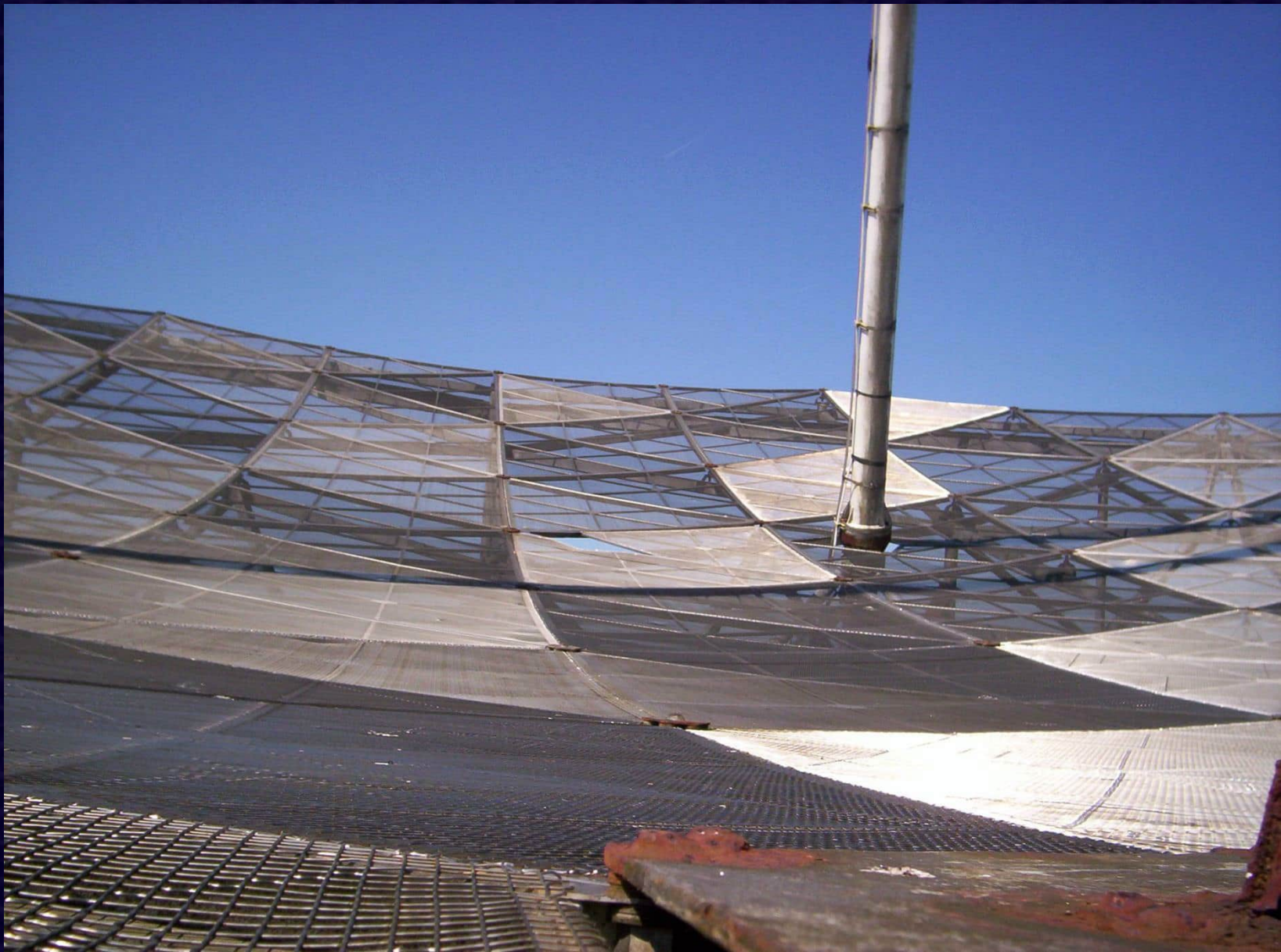





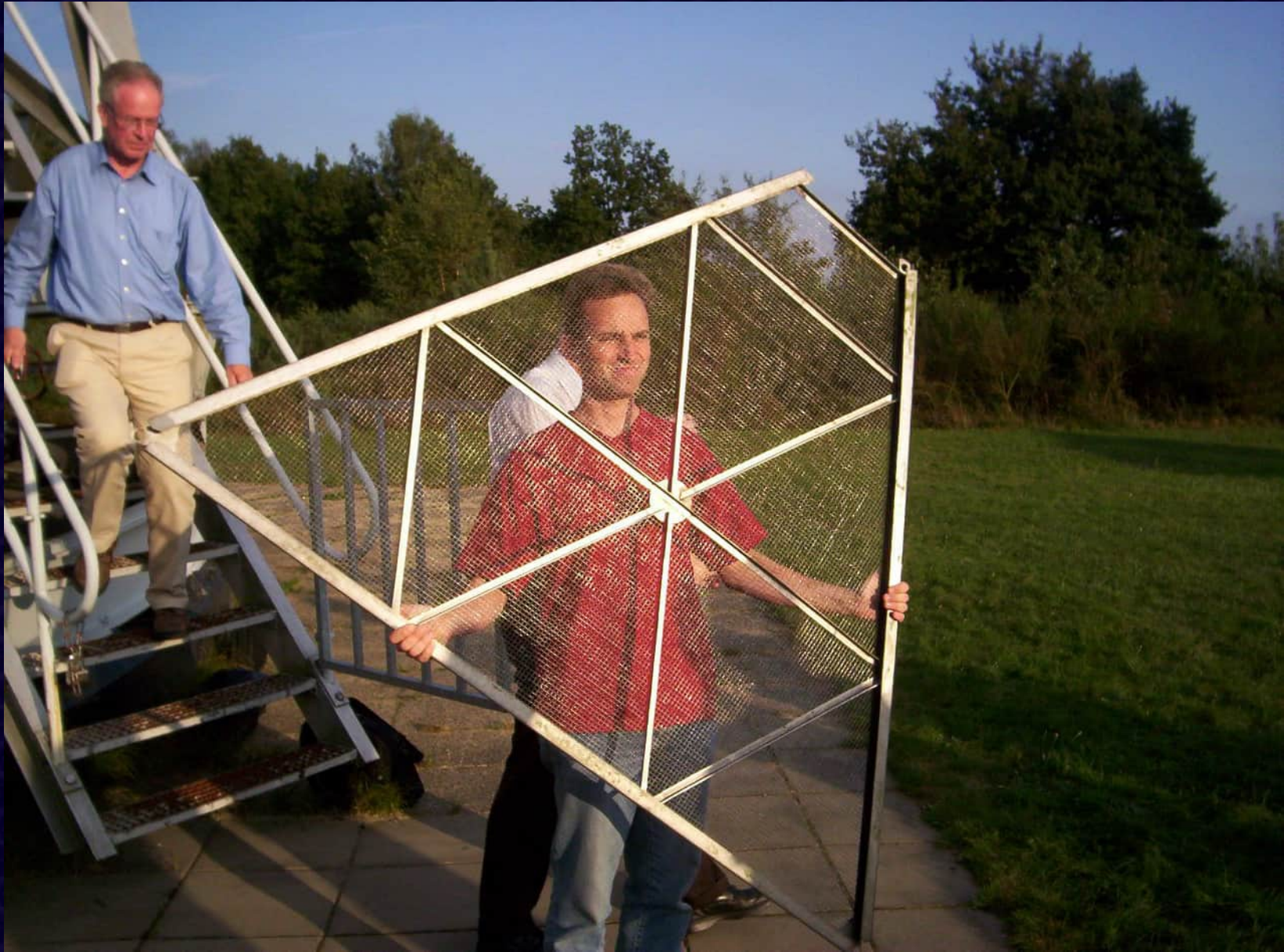

























































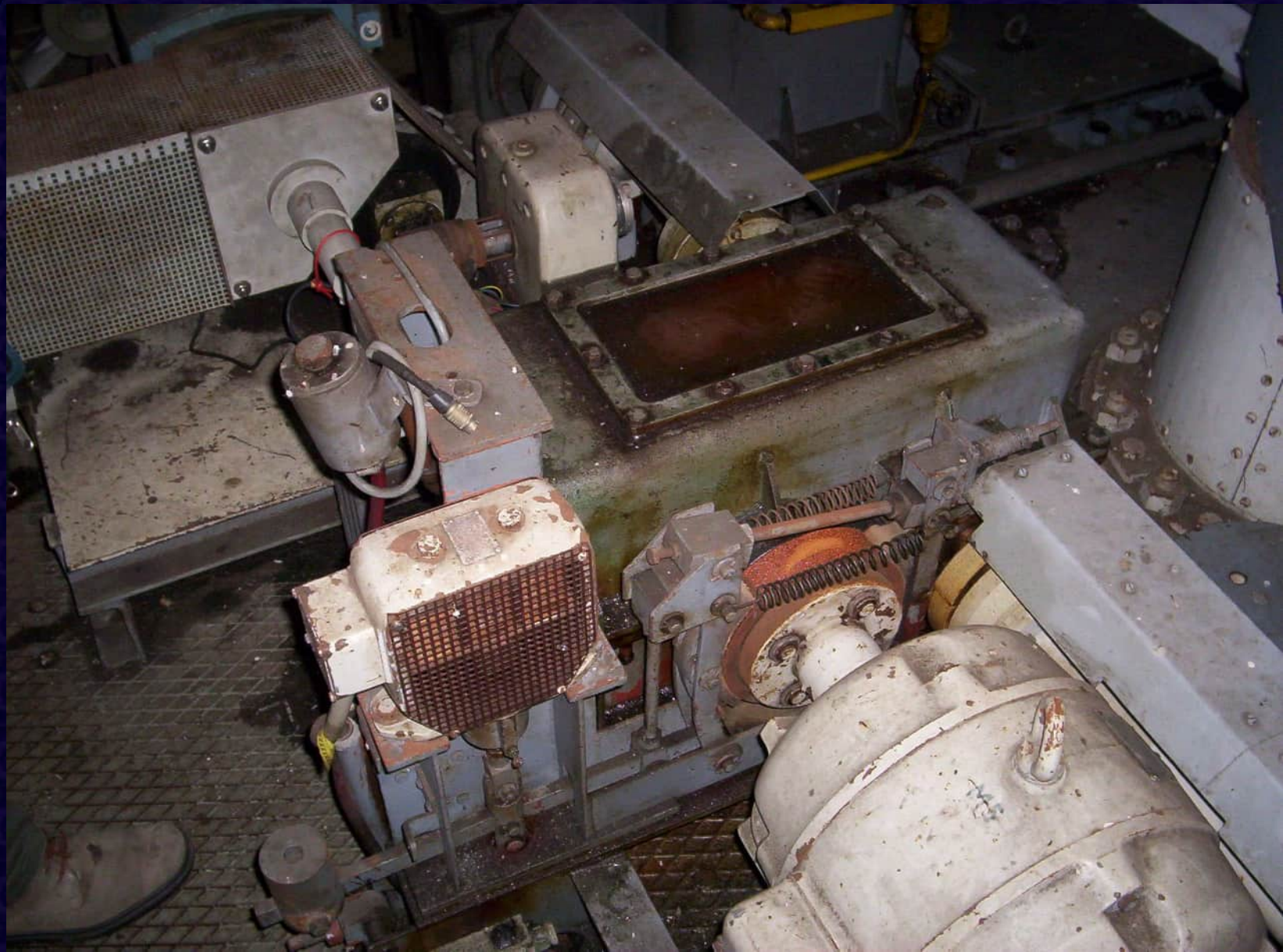













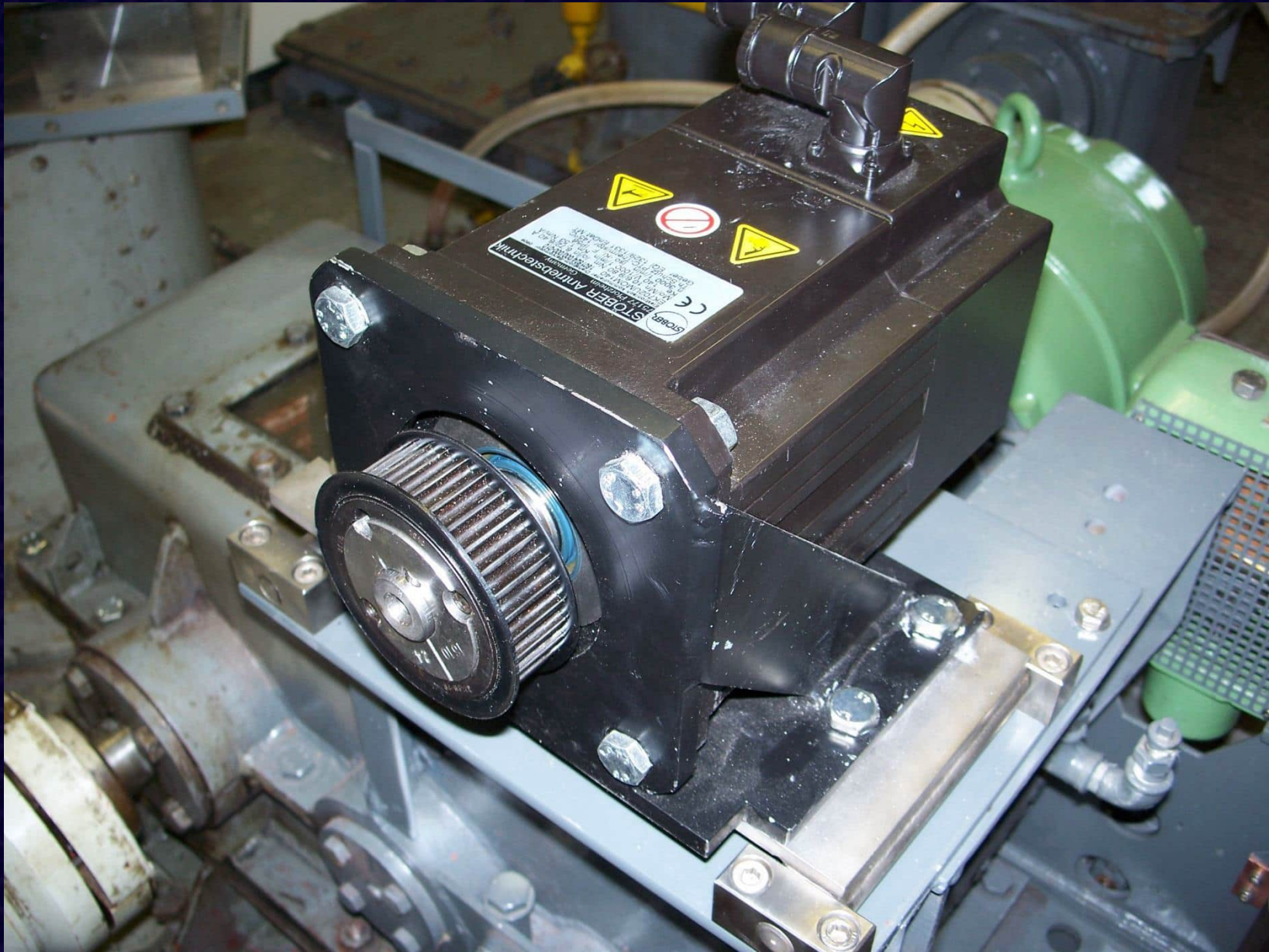







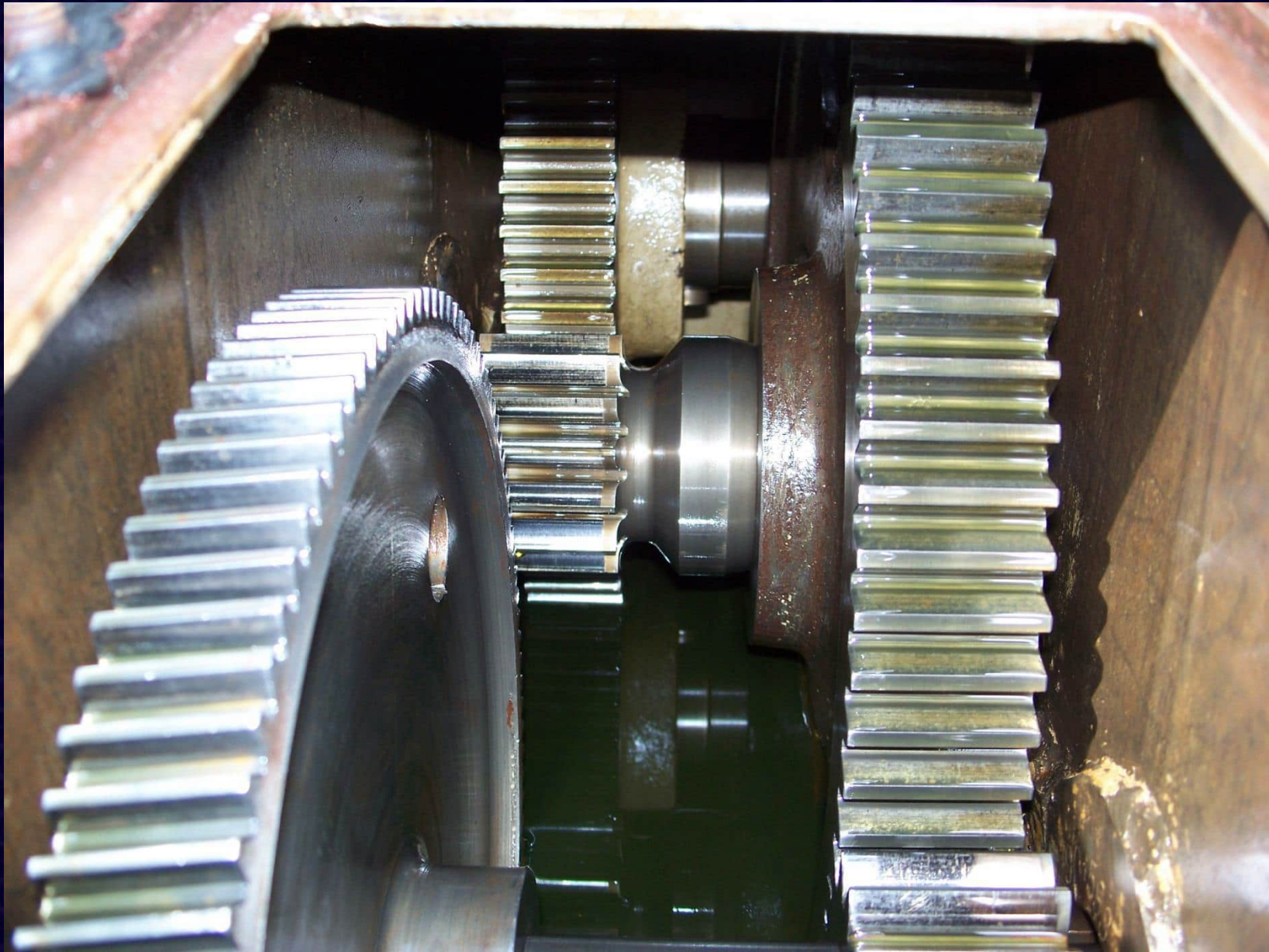

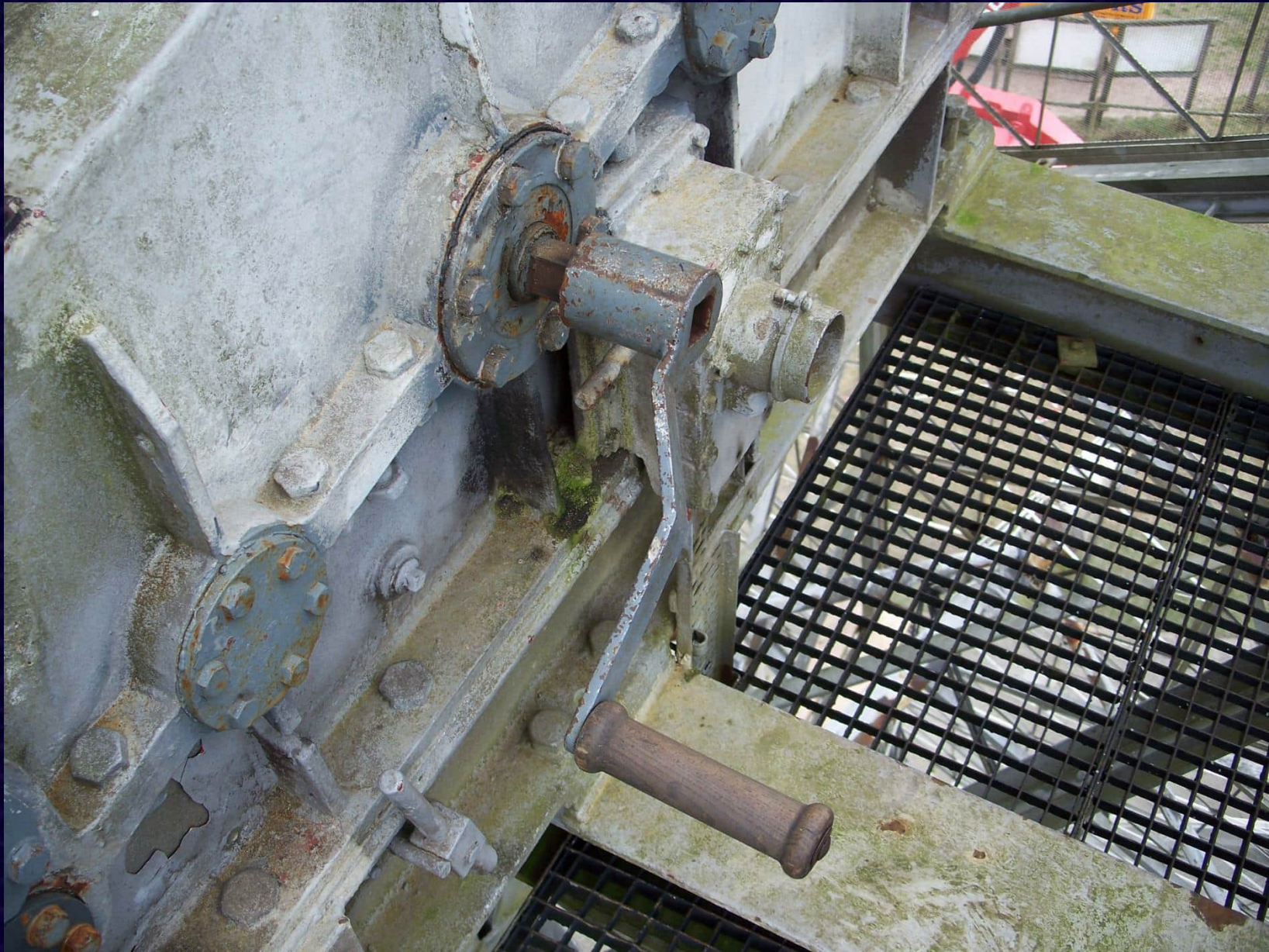









PE0SHF











**WWW.CAMRAS.NL**















PE0SHF

PA0PLY

PIET



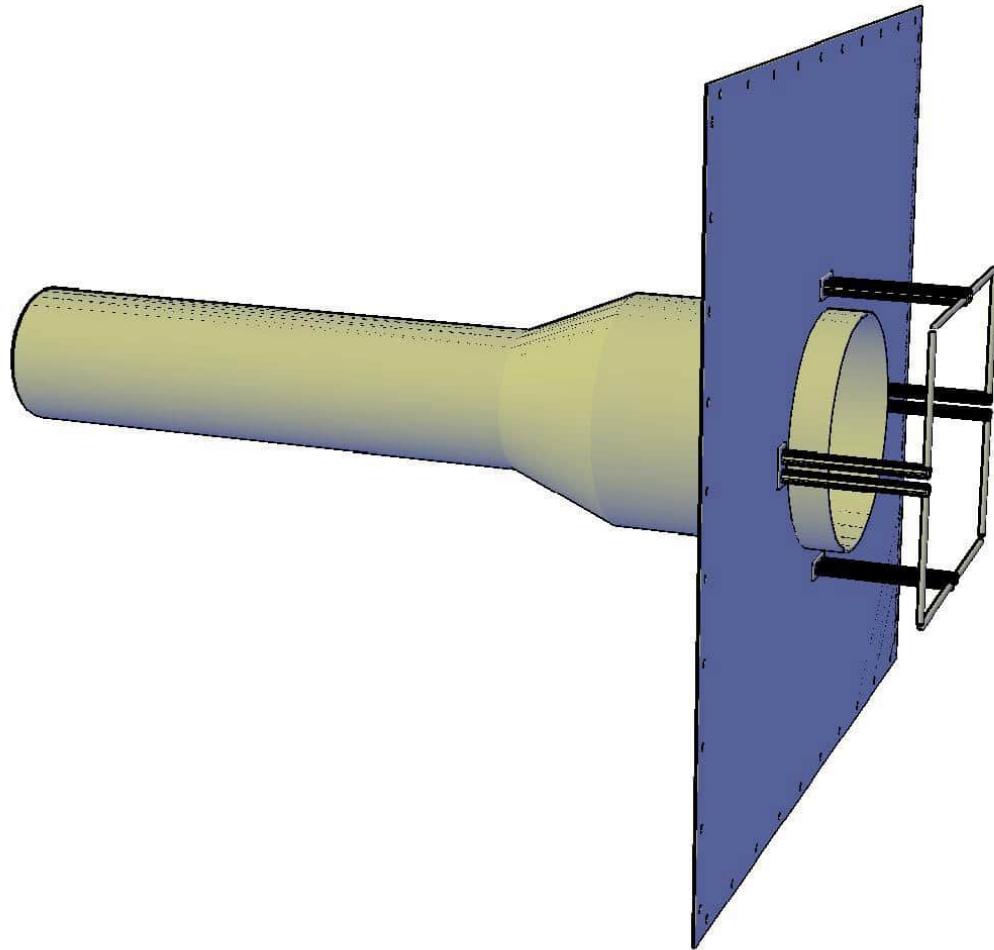

VK3UM design









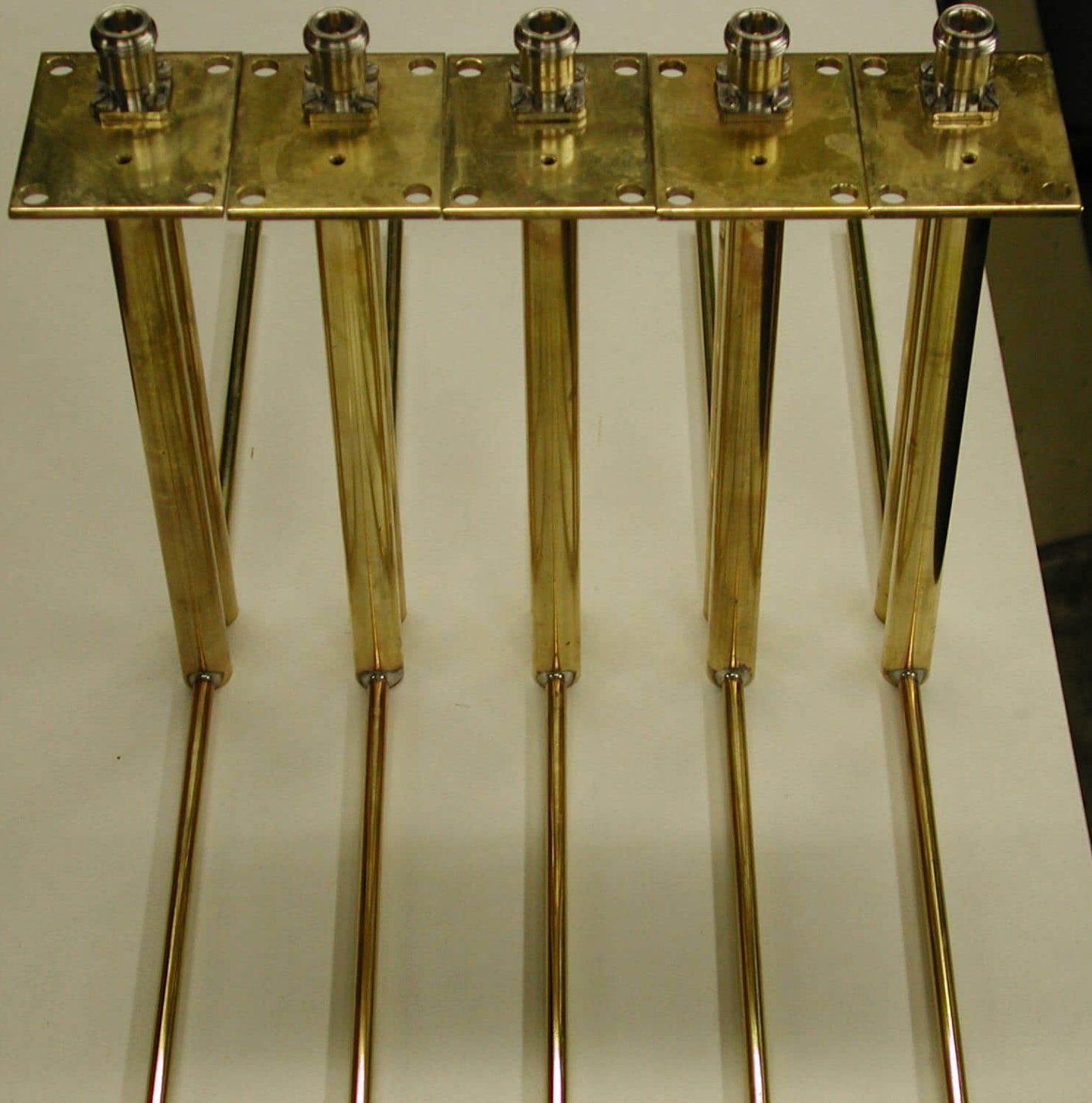

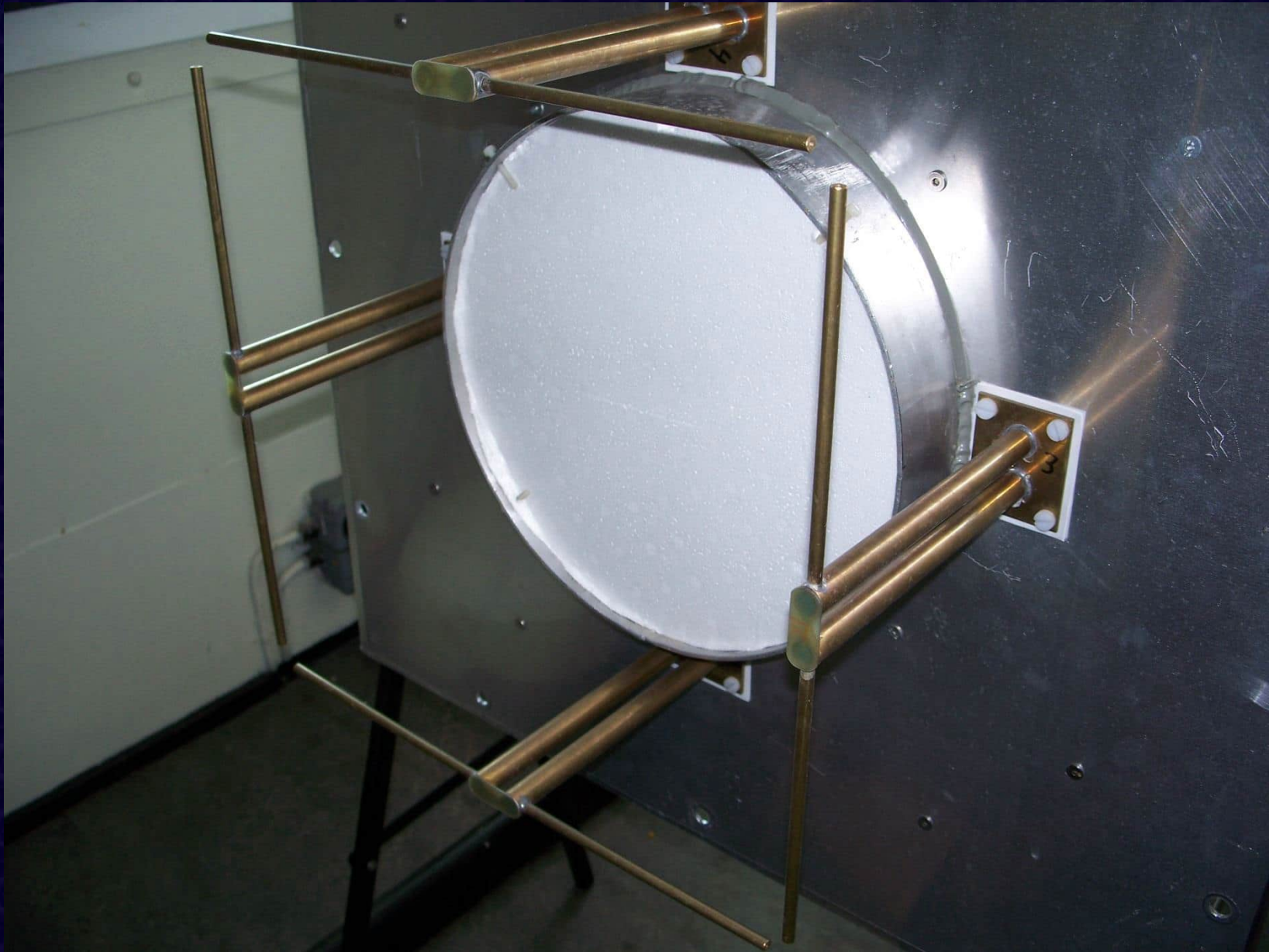









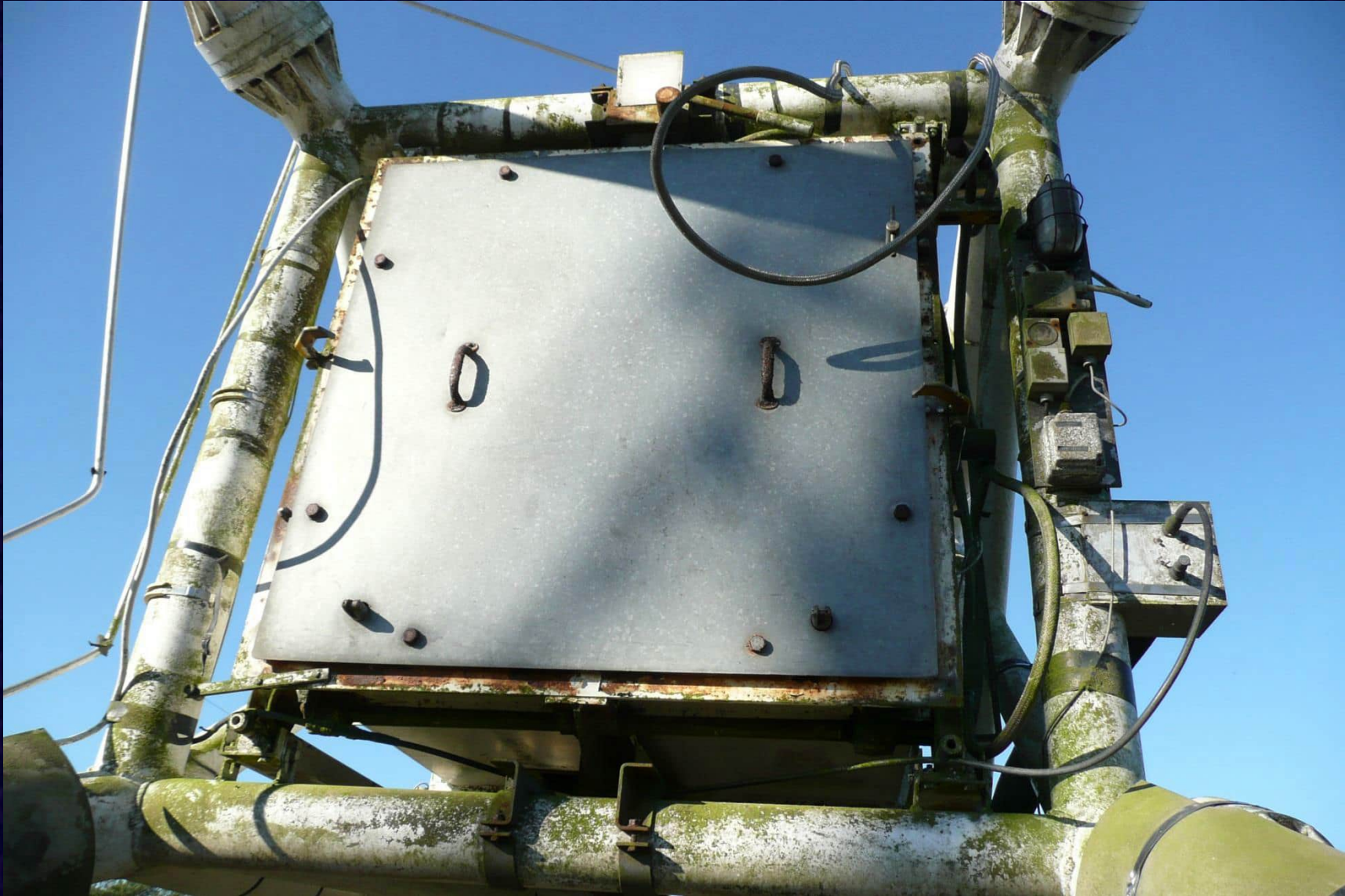

































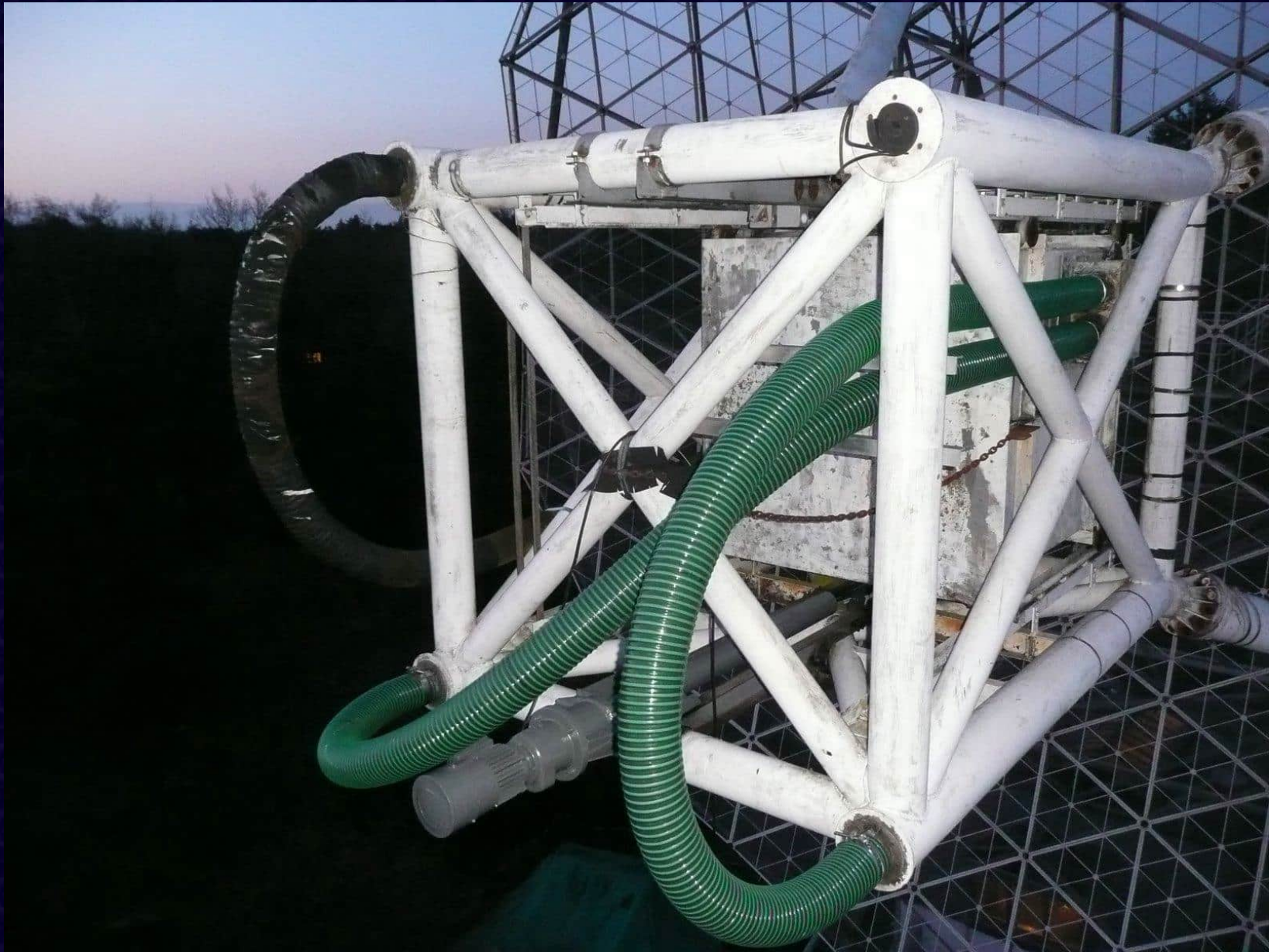

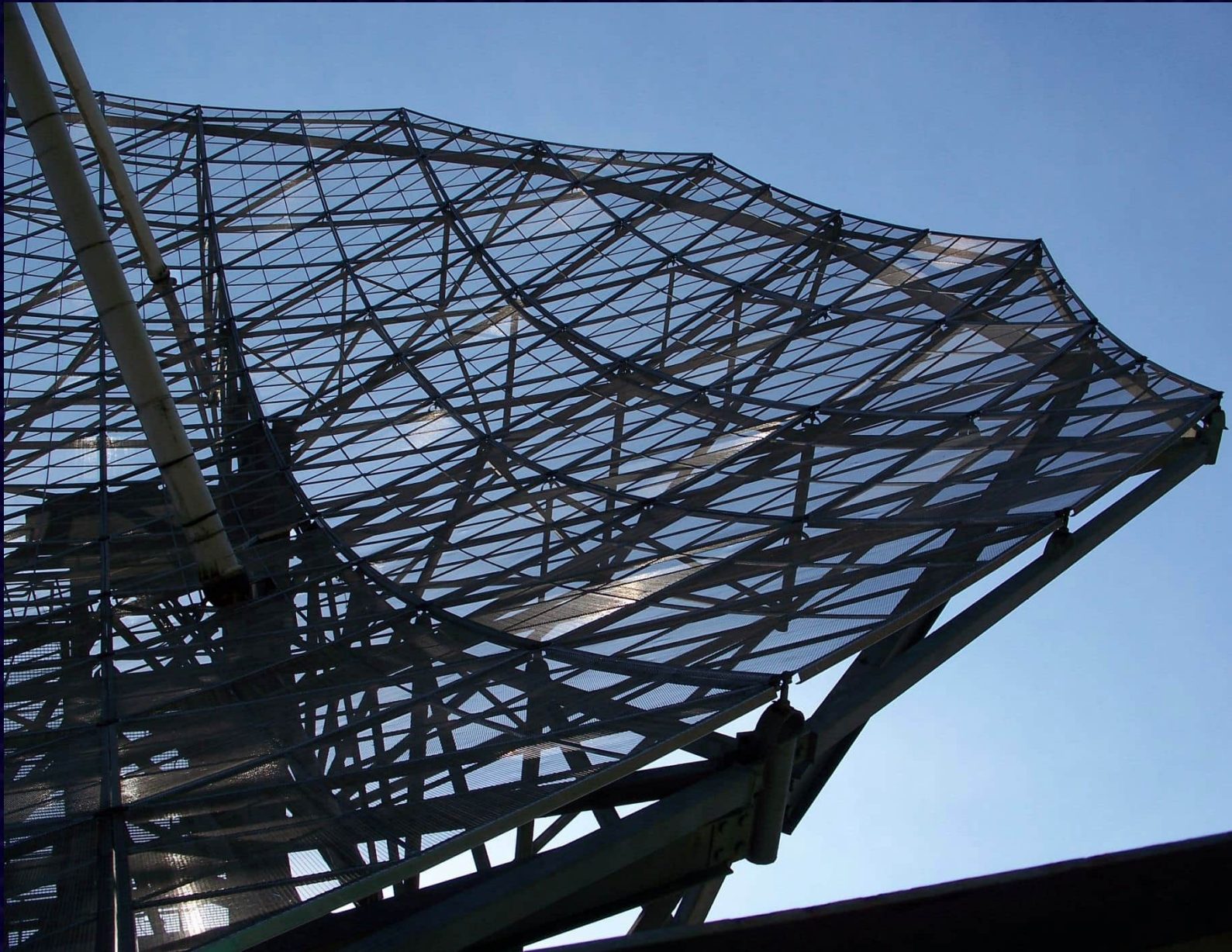



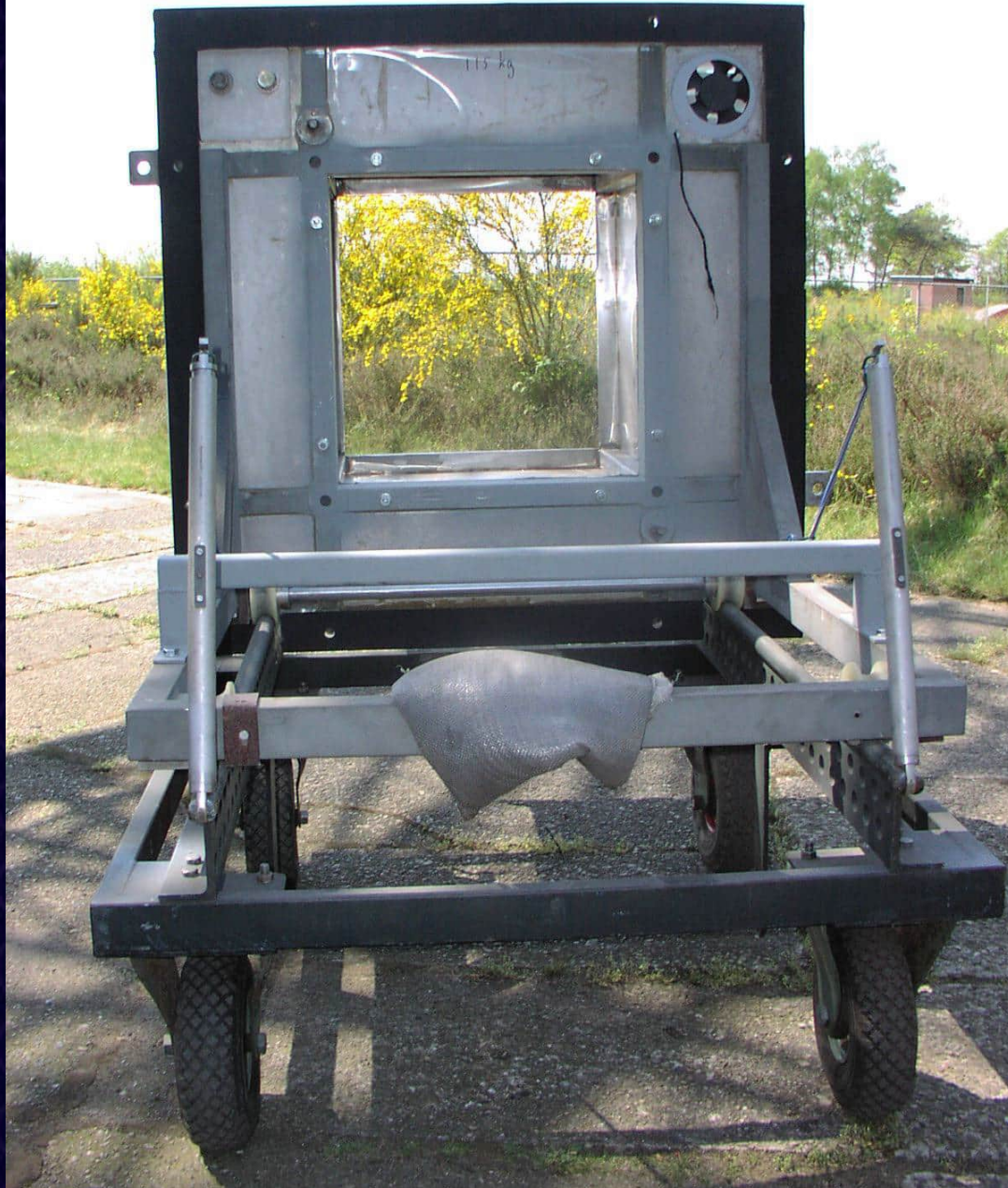

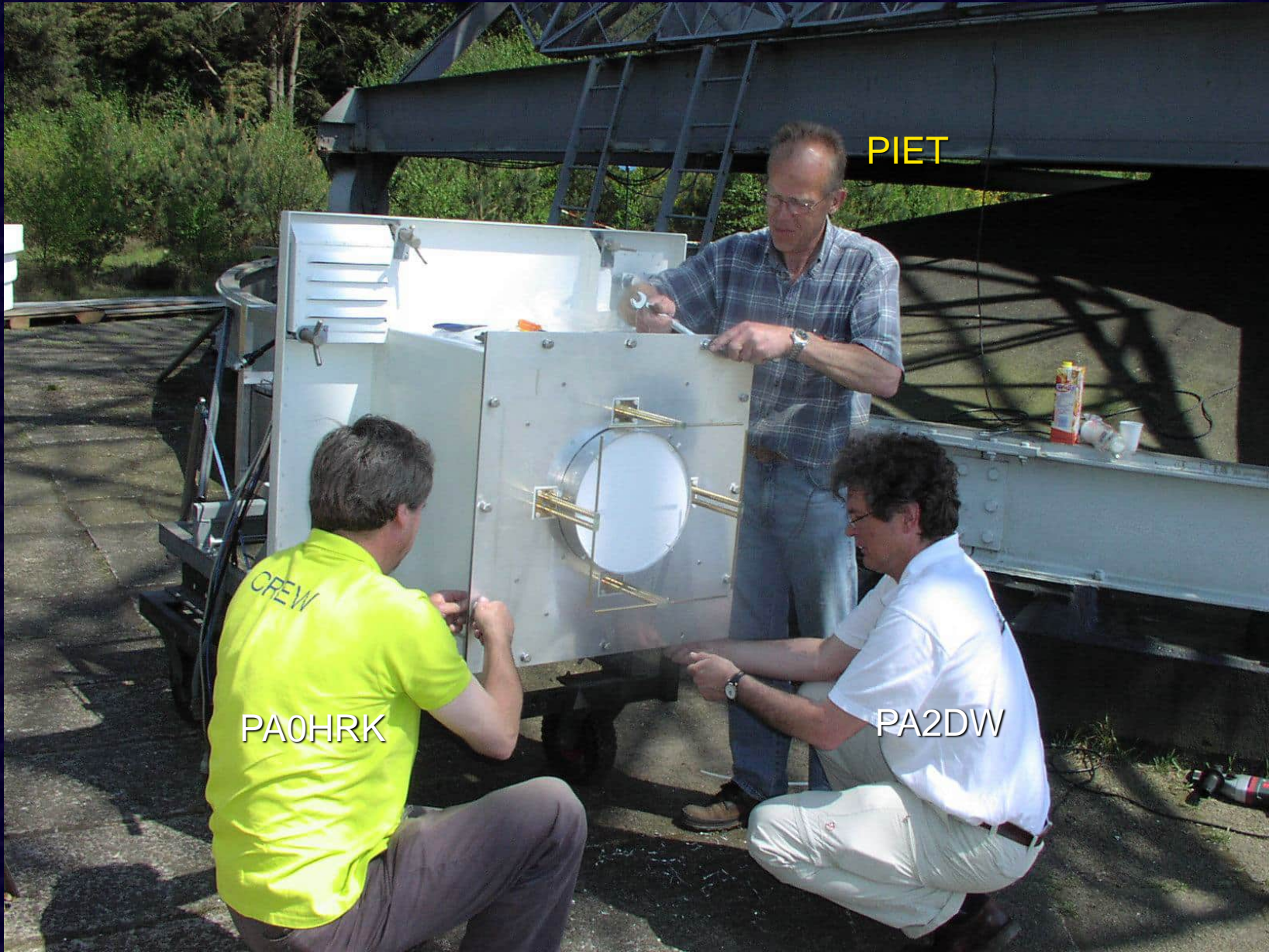

PIET

PA0HRK

PA2DW









# EME = Aarde Maan Aarde

- Ultieme uitdaging voor de radioamateur
- De te overbruggen afstand is ca. 800.000 km
- Grote paddemping. Bv 270 dB op 23 cm
- Alles moet kloppen



# DT ideaal voor EME!

- Hoge antennegain. Bv 48 dB op 23 cm
- Kleine openingshoek. 0,5 graad op 23 cm
- Ooit gebouwd voor 21 cm
- Bruikbaar van 2 m – 6 cm (en hoger?)
- Zeer radiostille locatie



PA3CEG







PA3FYM

PE0SHF

PA0HRK

PA3CEG

PA2DW

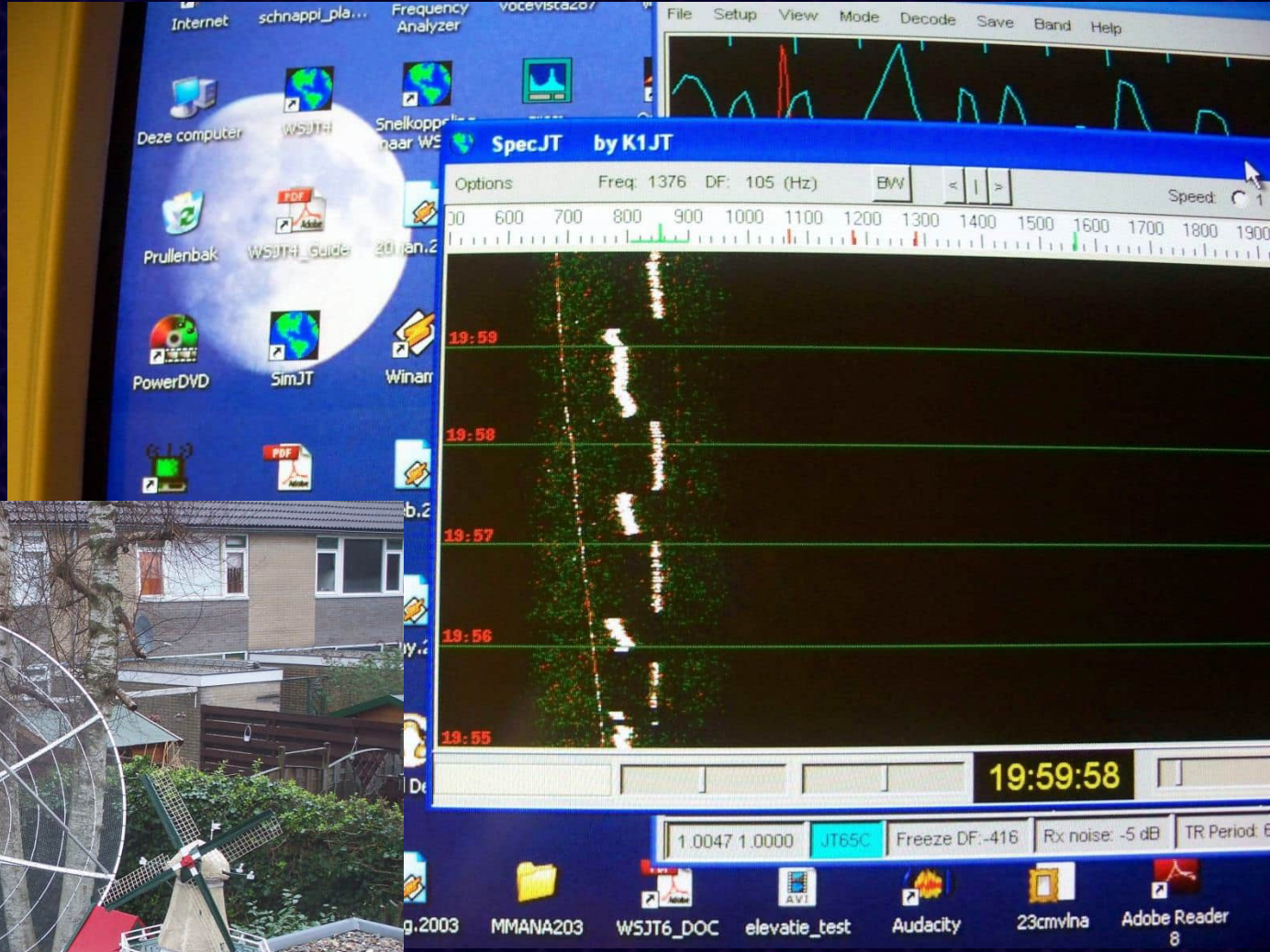

PA3FXB 3 m schotel





PE1RXQ

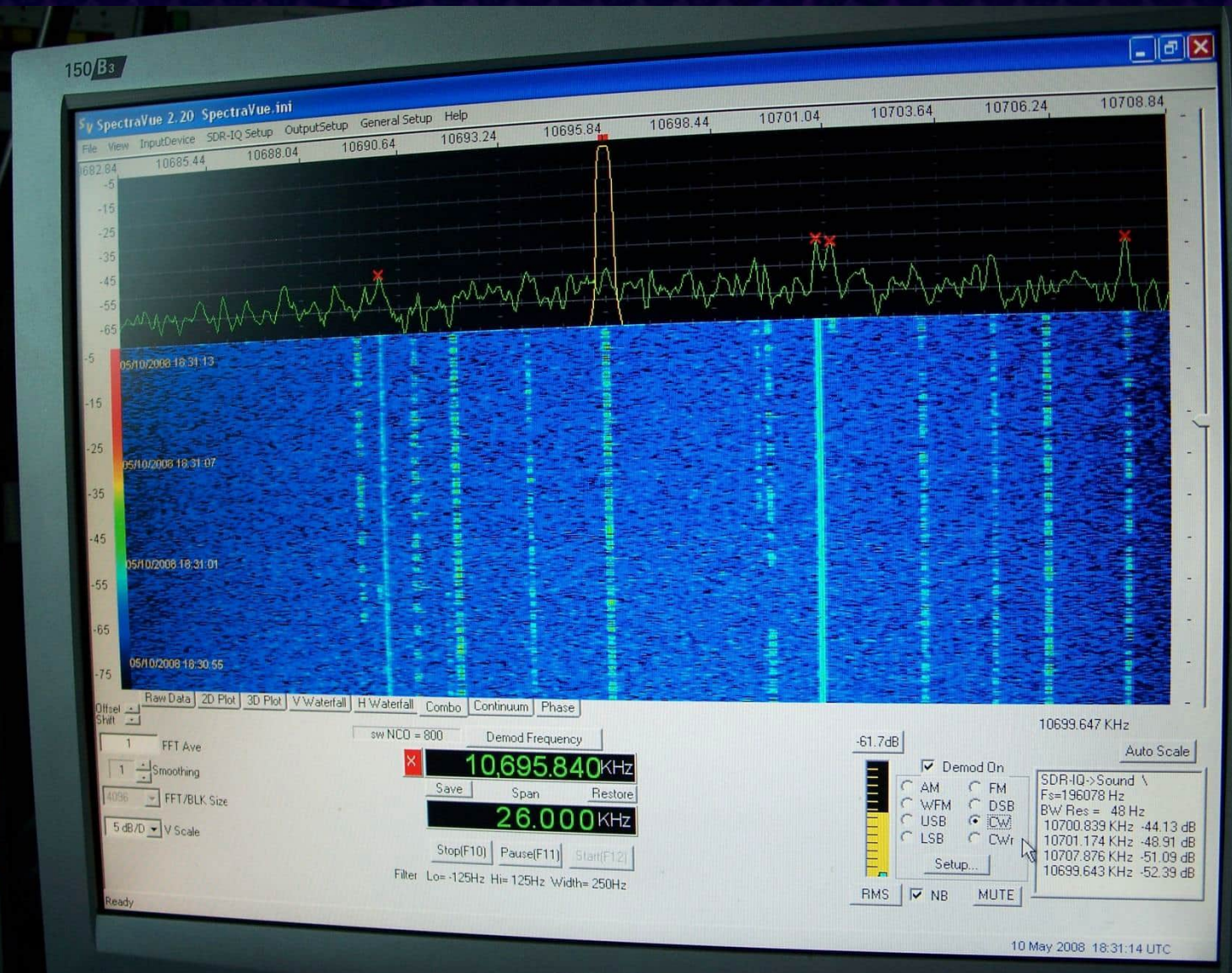

PHILIPS



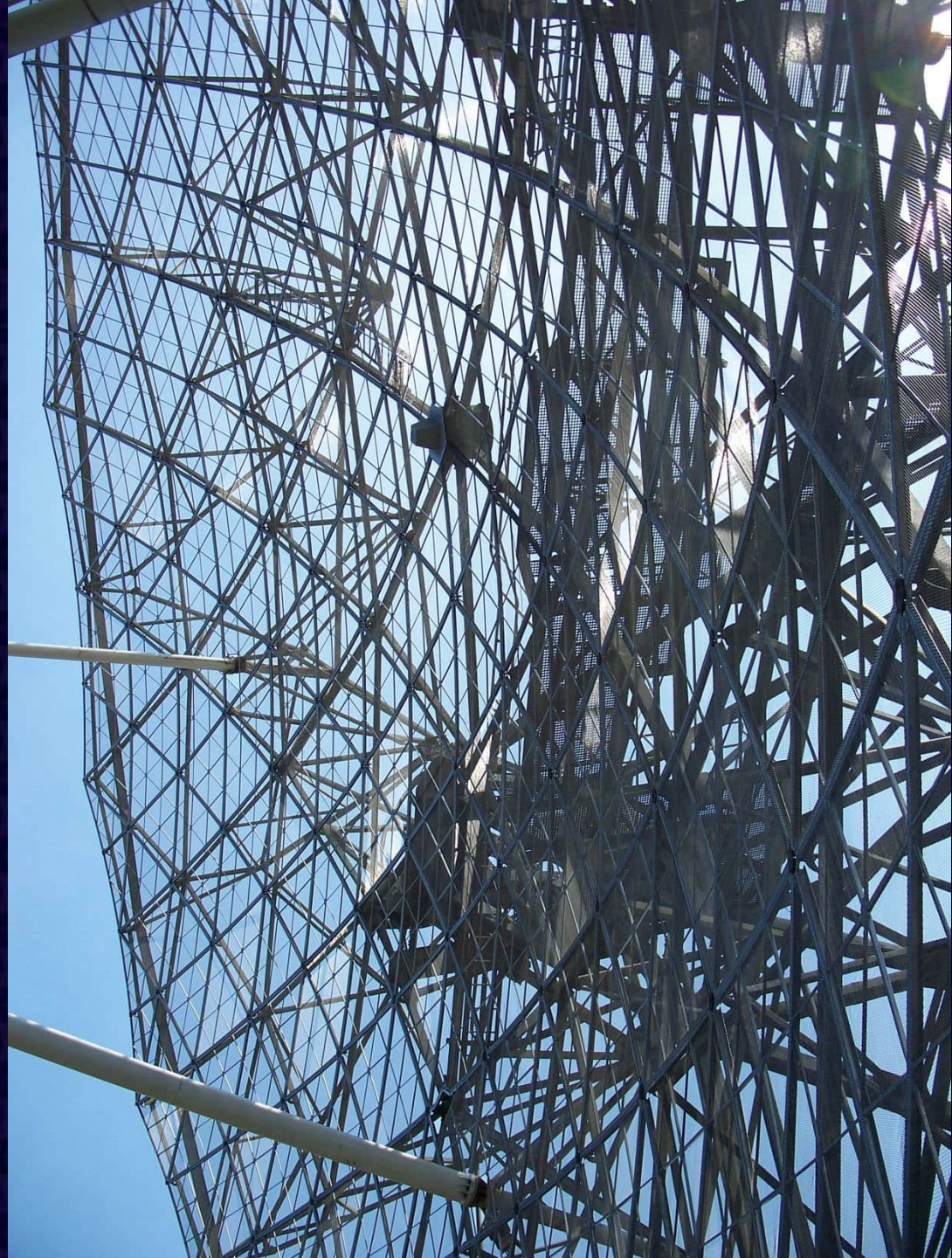









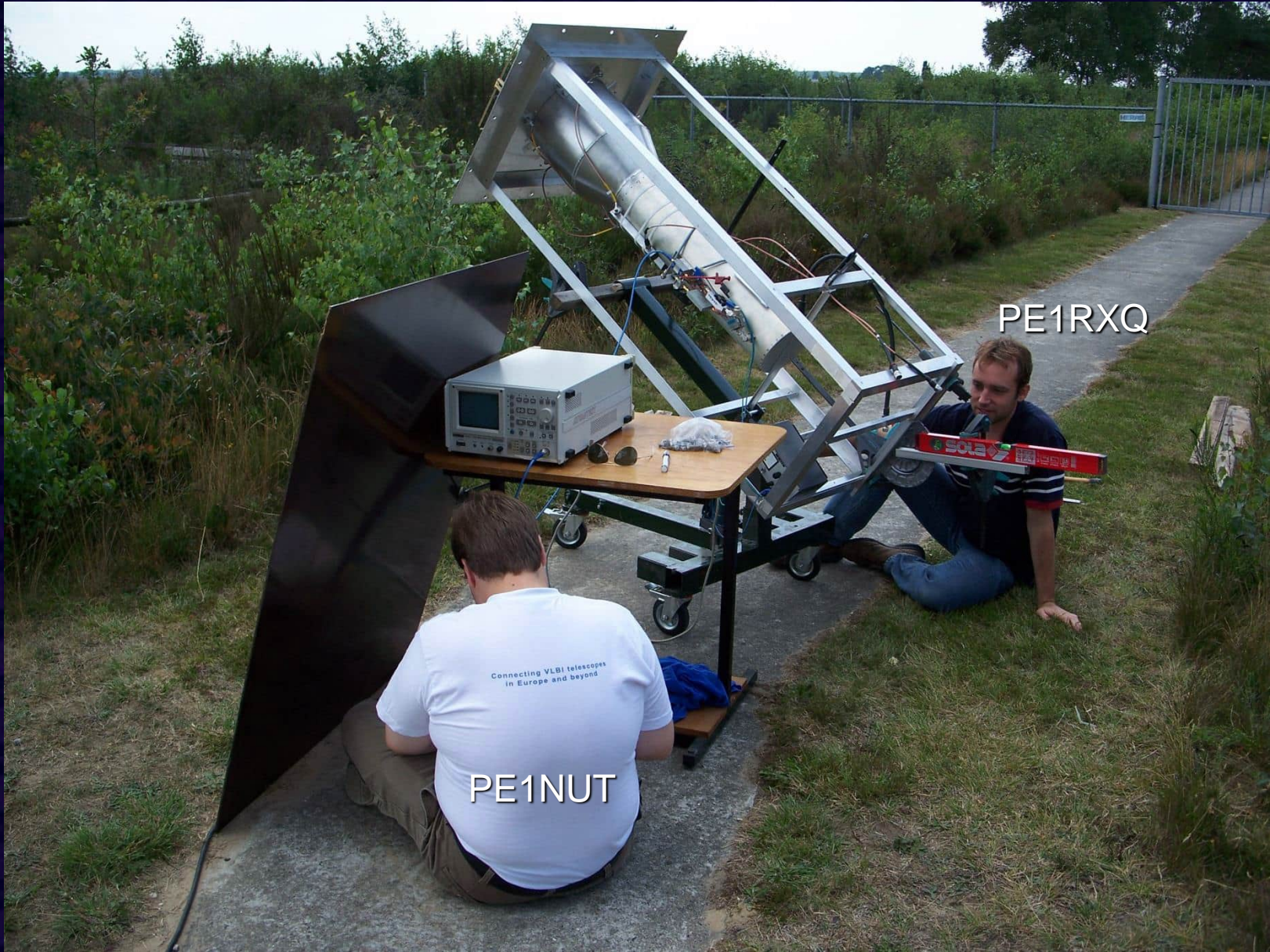

PE1RXQ

Connecting VLBI telescopes  
in Europe and beyond

PE1NUT





PE0SHF











### Driftscans DT 2008-07-27

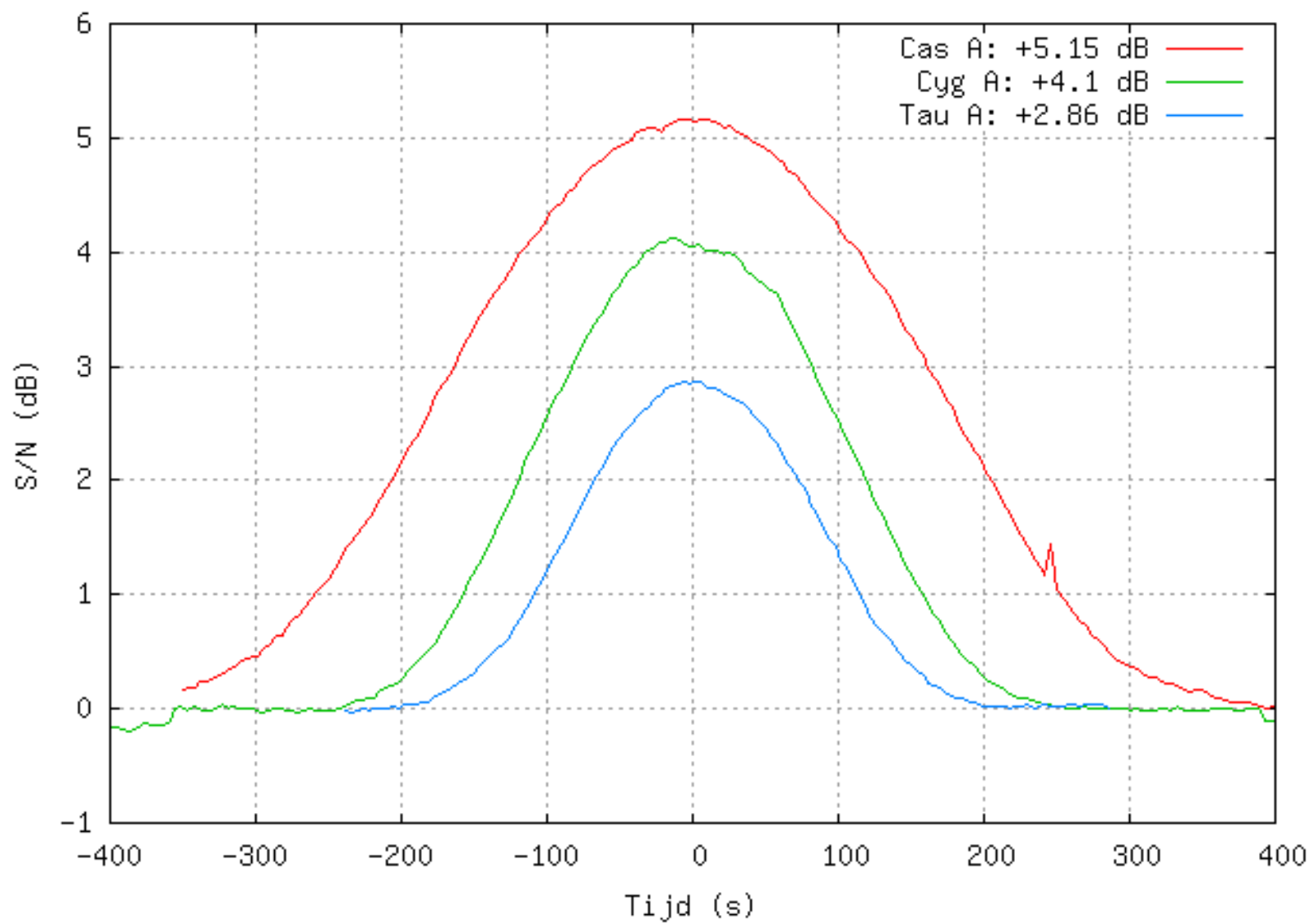



DT openingshoek 2008-07-27

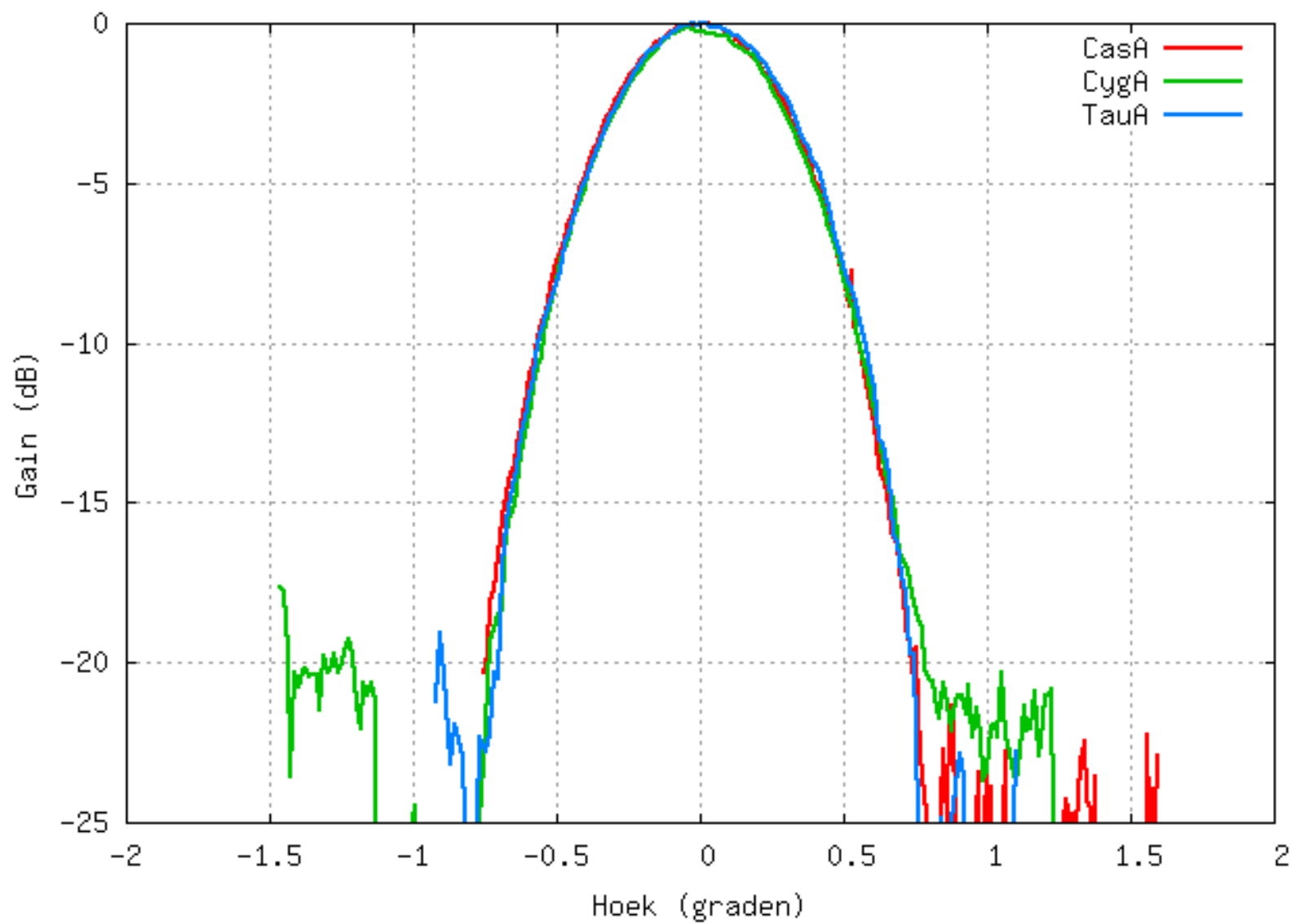

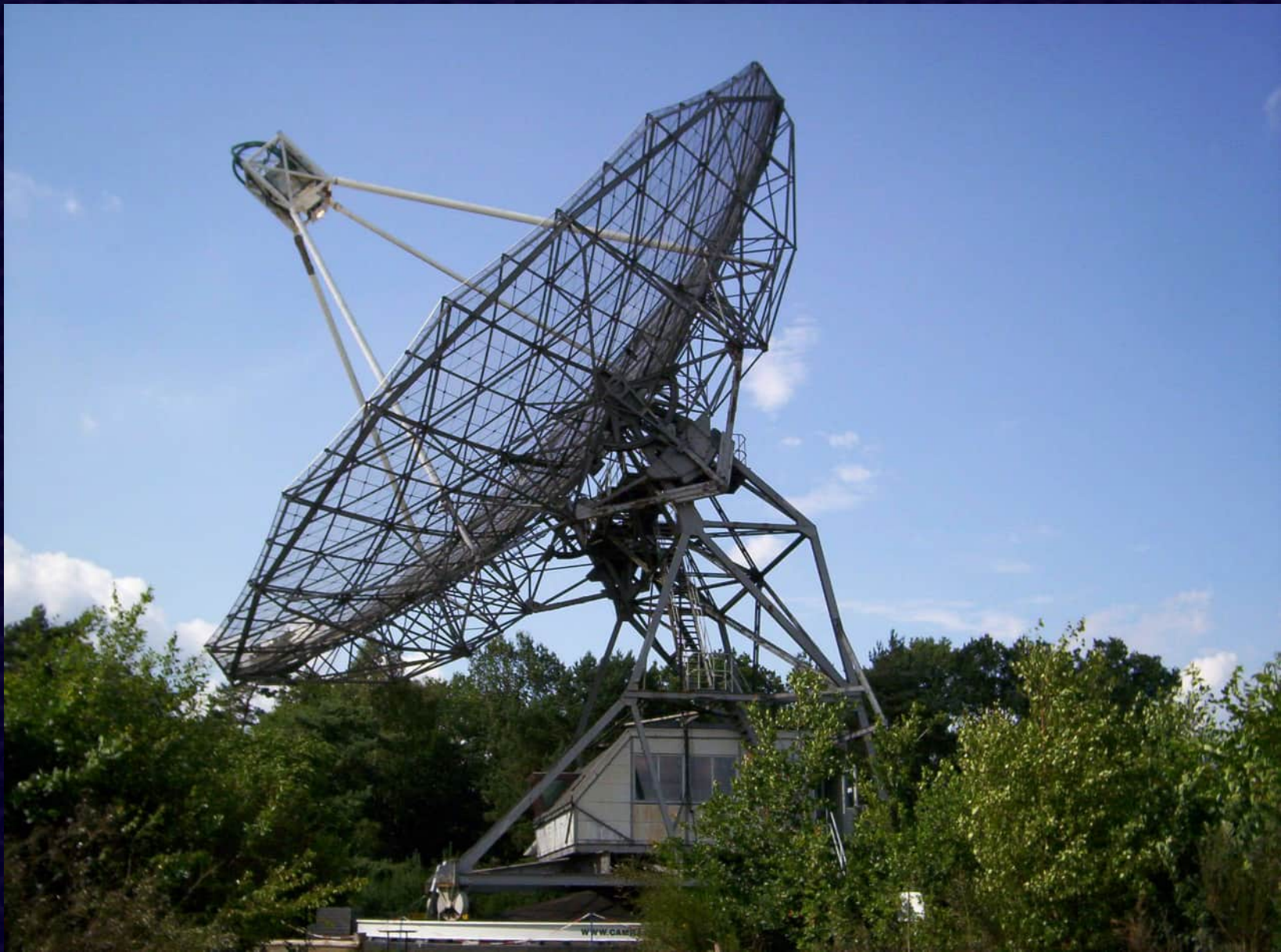





# Glasvezelkabel (aug 2009)











# EME resultaten

> 1500 EME contacten

18 Firsts

Veel “kleine” stations (bv 1 yagi, 20 W)

Contact met 3 mW met VK7MO op 23 cm

Echoes of Apollo

SSTV

Maanradar

Klingon







# WebSDR

CAMRAS - WebSDR - Windows Internet Explorer

http://websdr.camras.nl:8901/

Favorieten CAMRAS - WebSDR

C.A. Muller Radio Astronomie Station

"Toptechniek voor iedereen"

**23cm EME signals recorded using the 25 m dish in Dwingeloo.**

Currently, there is no live reception. Instead, we're playing a **recording** made during the ARRL EME contest of October 10 around 2215 UTC.

More WebSDR receivers for other bands can be found via <http://www.websdr.org/>.

**Note:** you need both *Java* and *JavaScript* enabled for this page to work properly. If you don't hear anything, probably Java is disabled or its version is too old (i.e., pre-1.4.2).

Please log in by typing your name or callsign here (it will be saved for later visits in a cookie):

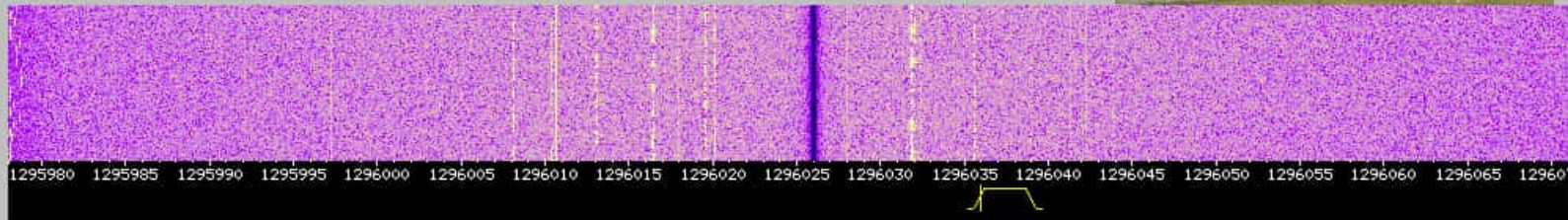



9 mei 2008 – 28 april 2012,  
een prachtige tijd

Maar nu....

De GROTE restauratie !!

























































HÖPFE NEDLIFT

MultiPoint  
CONSTRUCTION SYSTEMS







































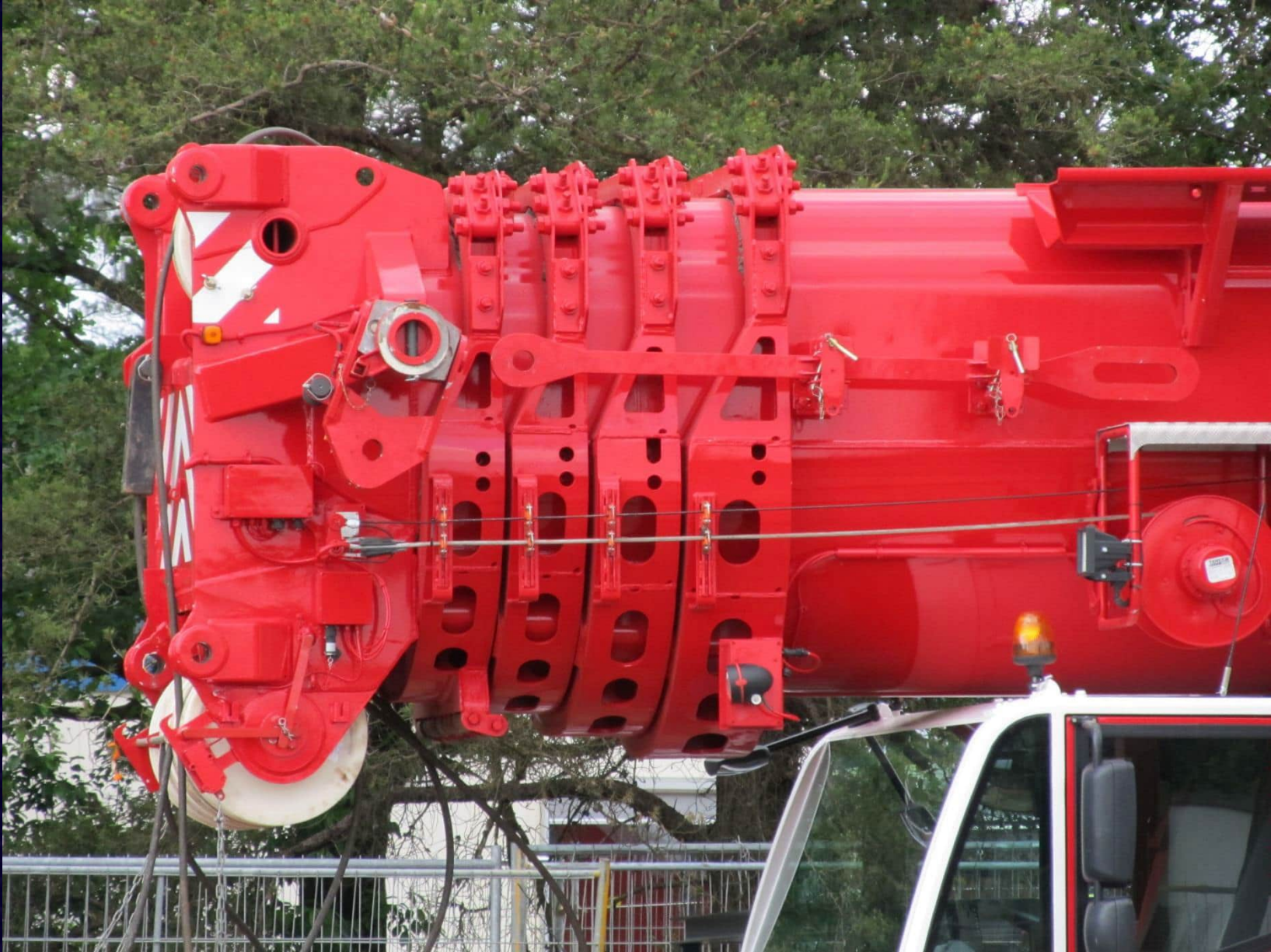











K5002

WAGENBORG

[www.wagenborg.com](http://www.wagenborg.com)







































GJALTEMA.EU



















































































































011118-18















































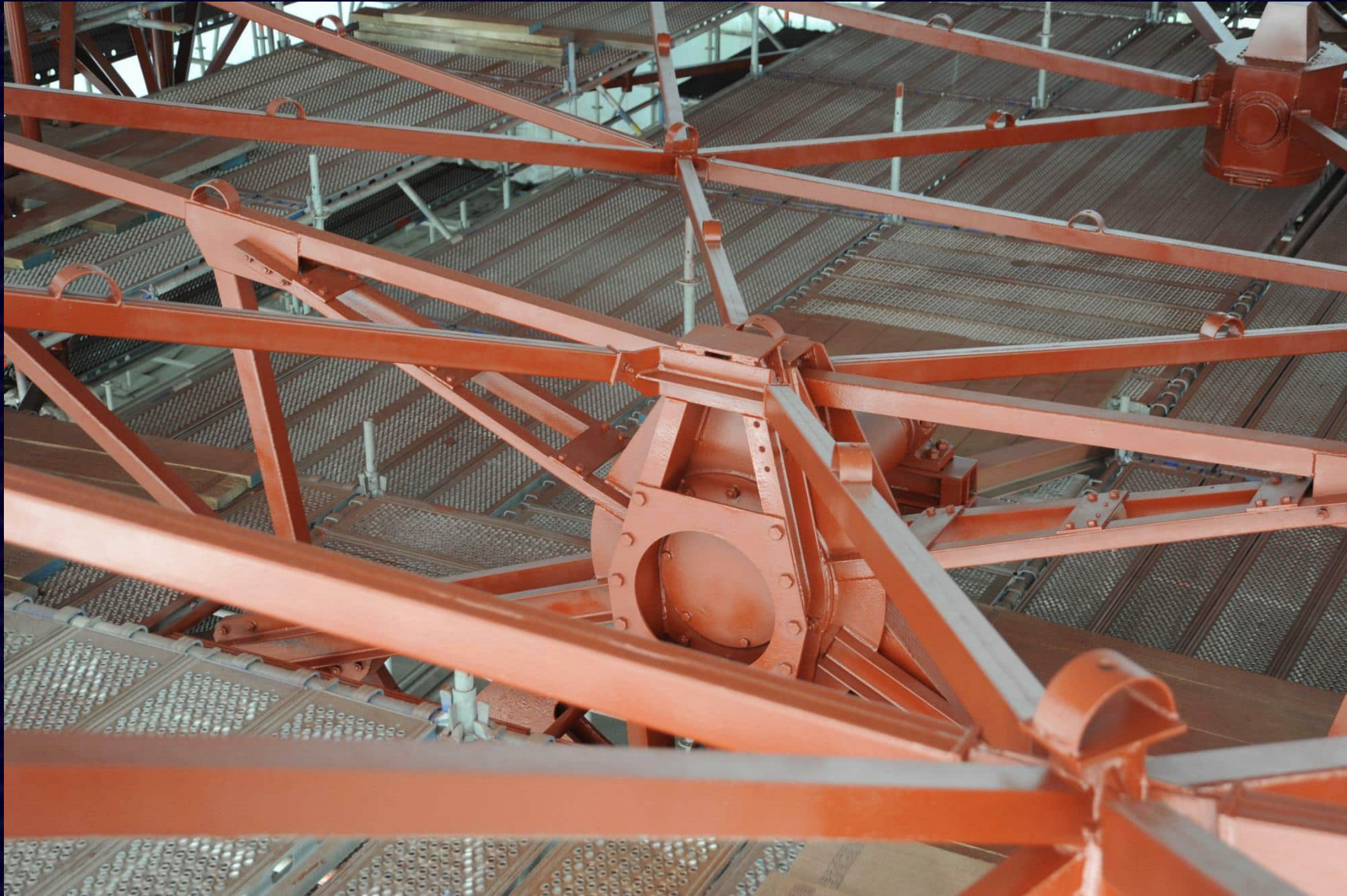





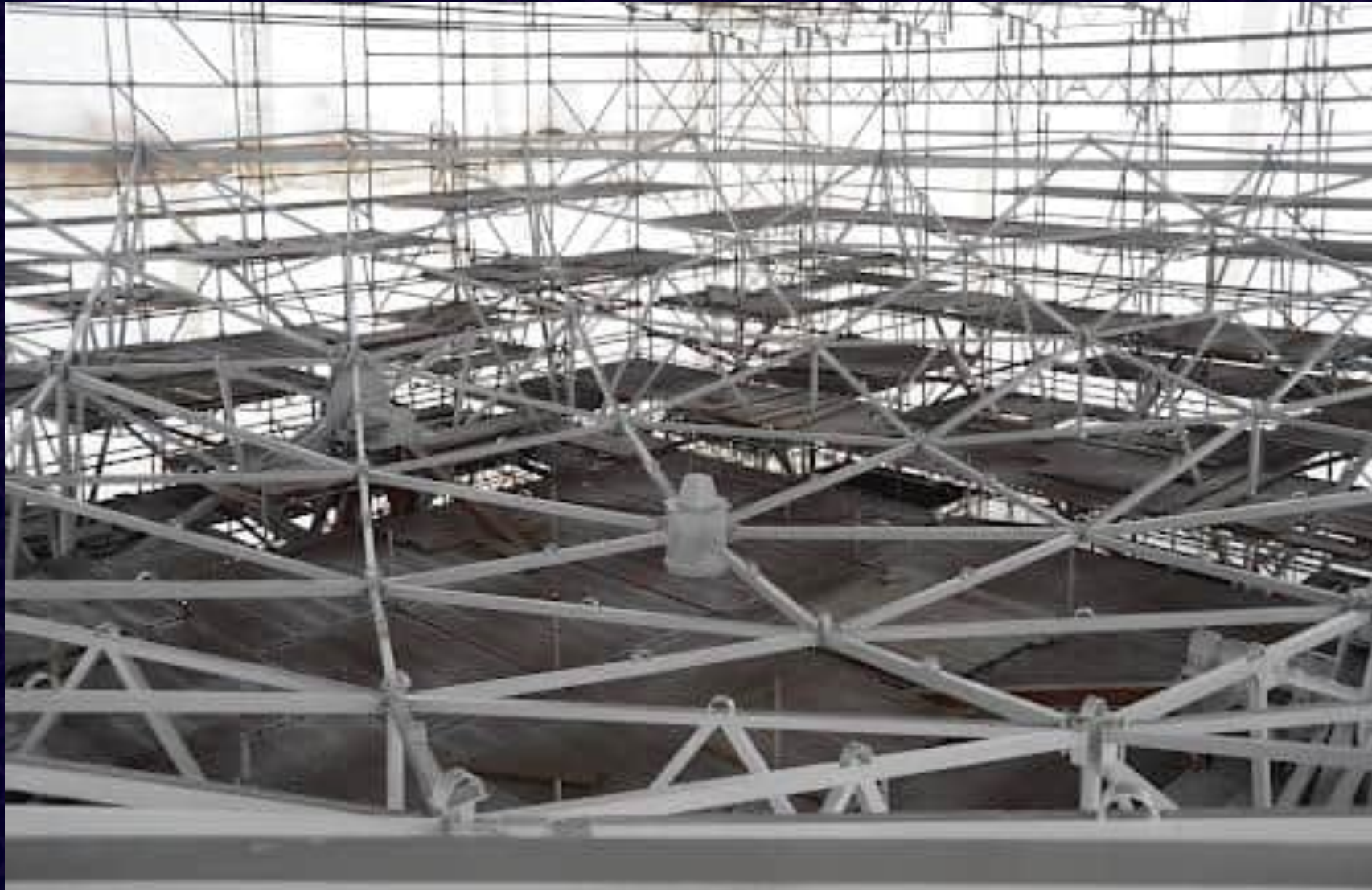































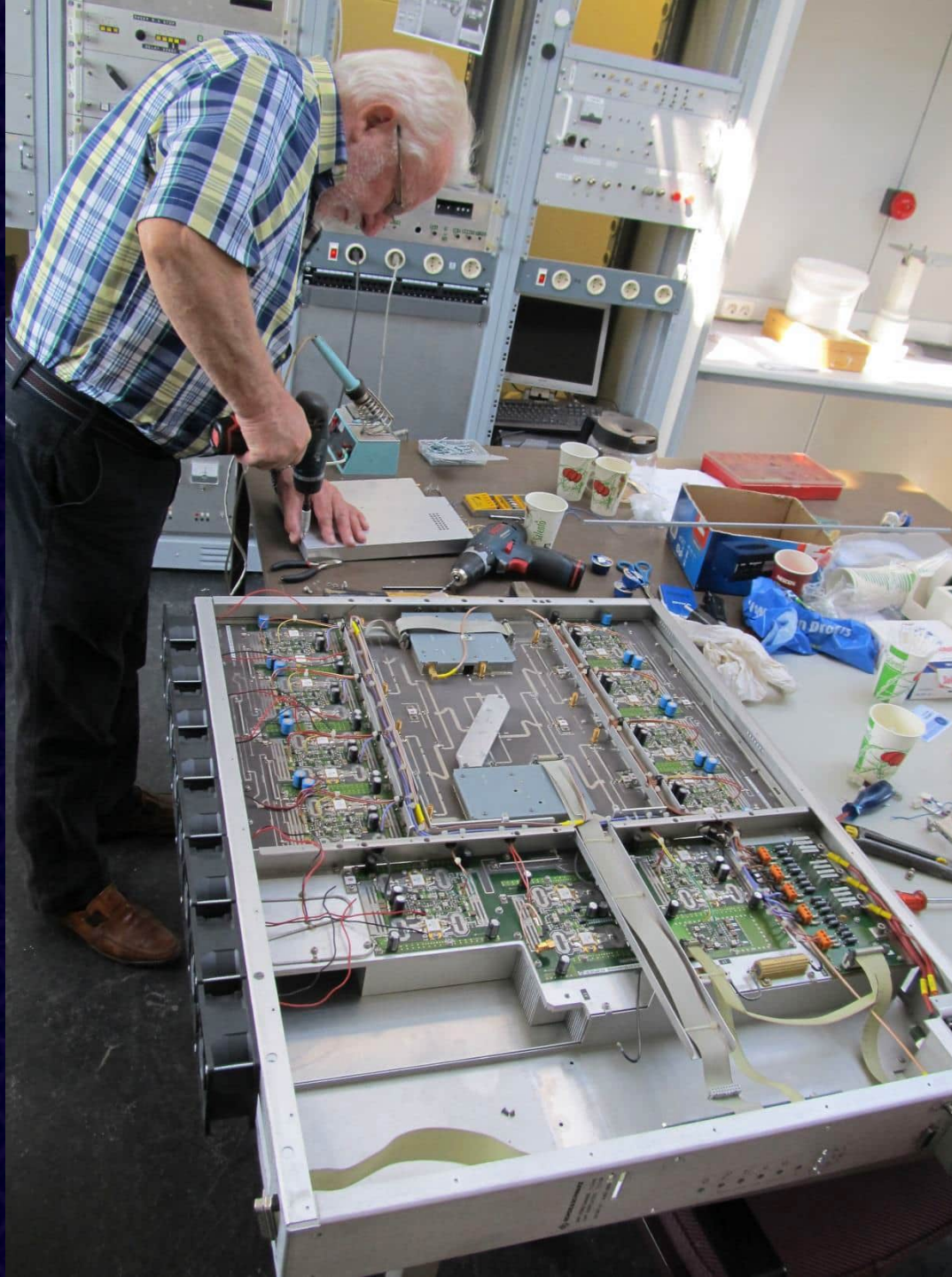











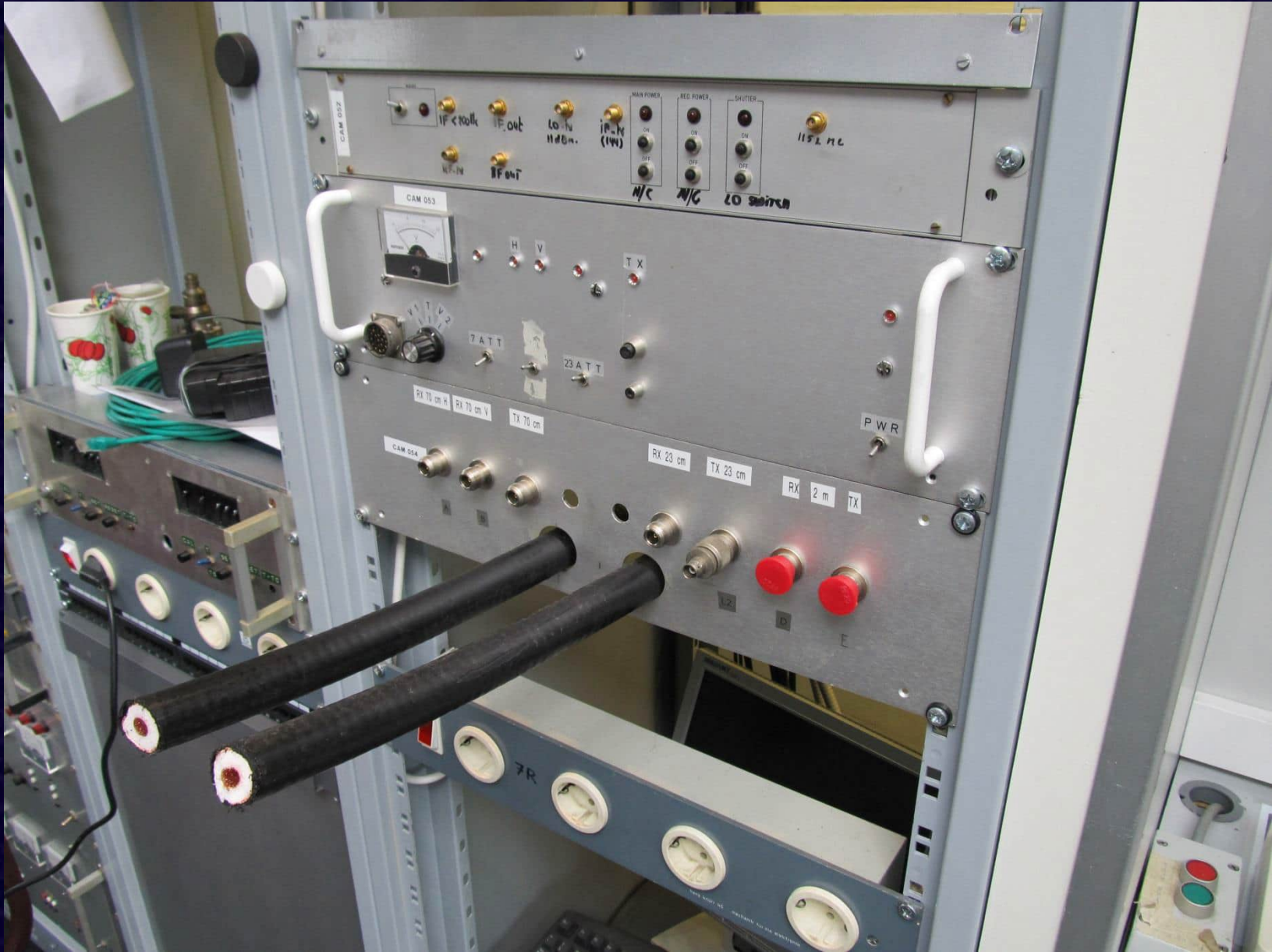









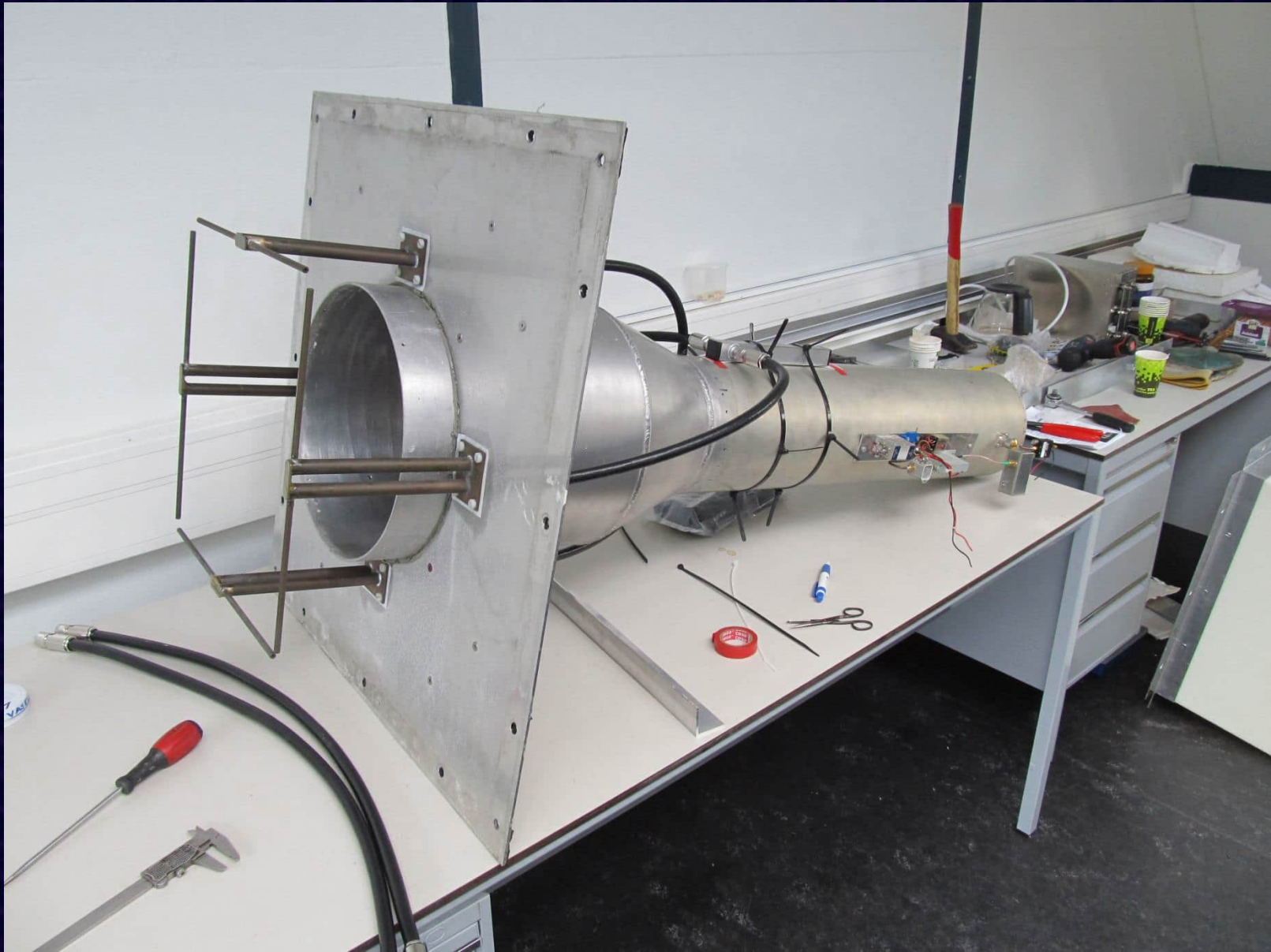





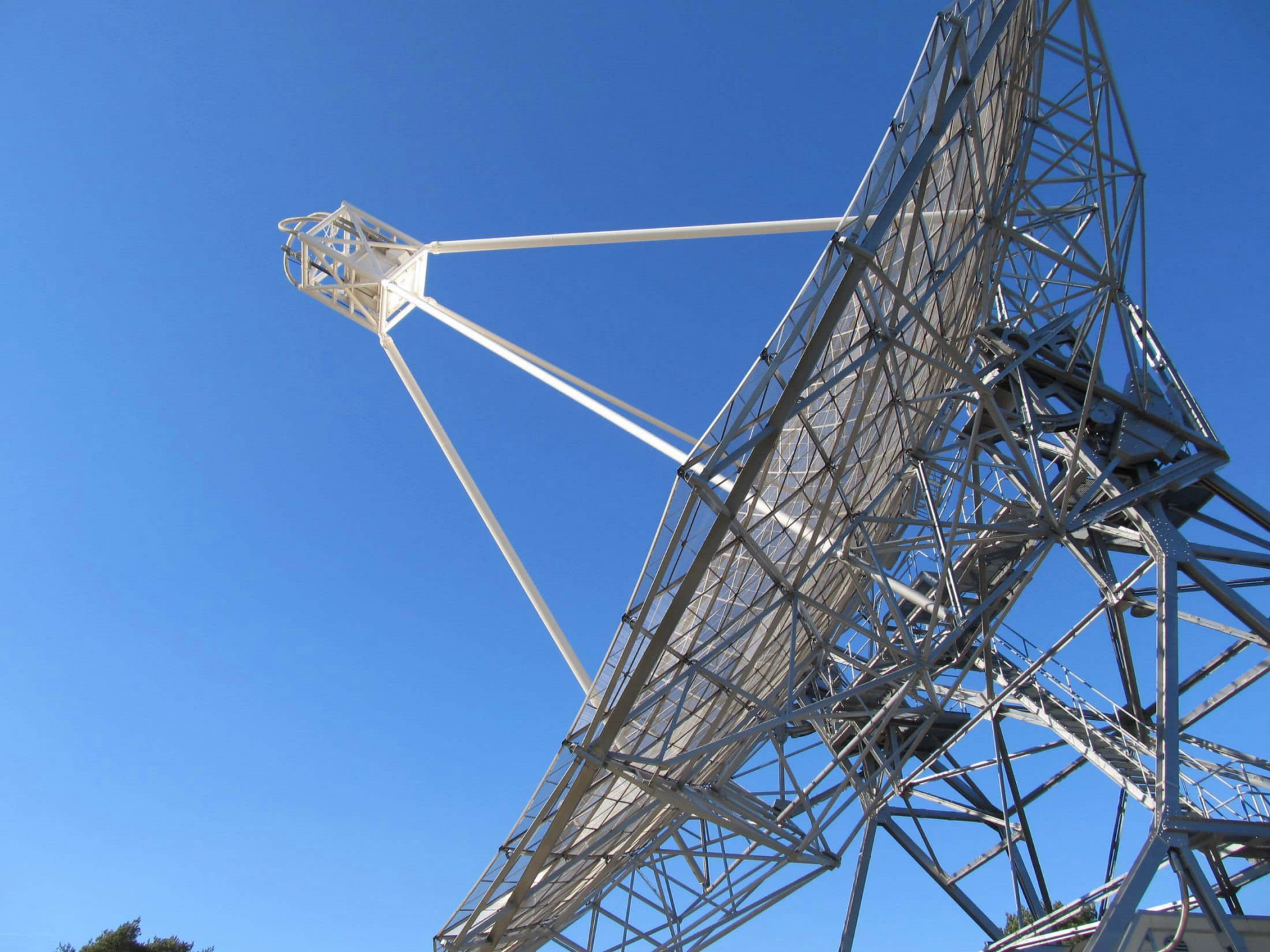



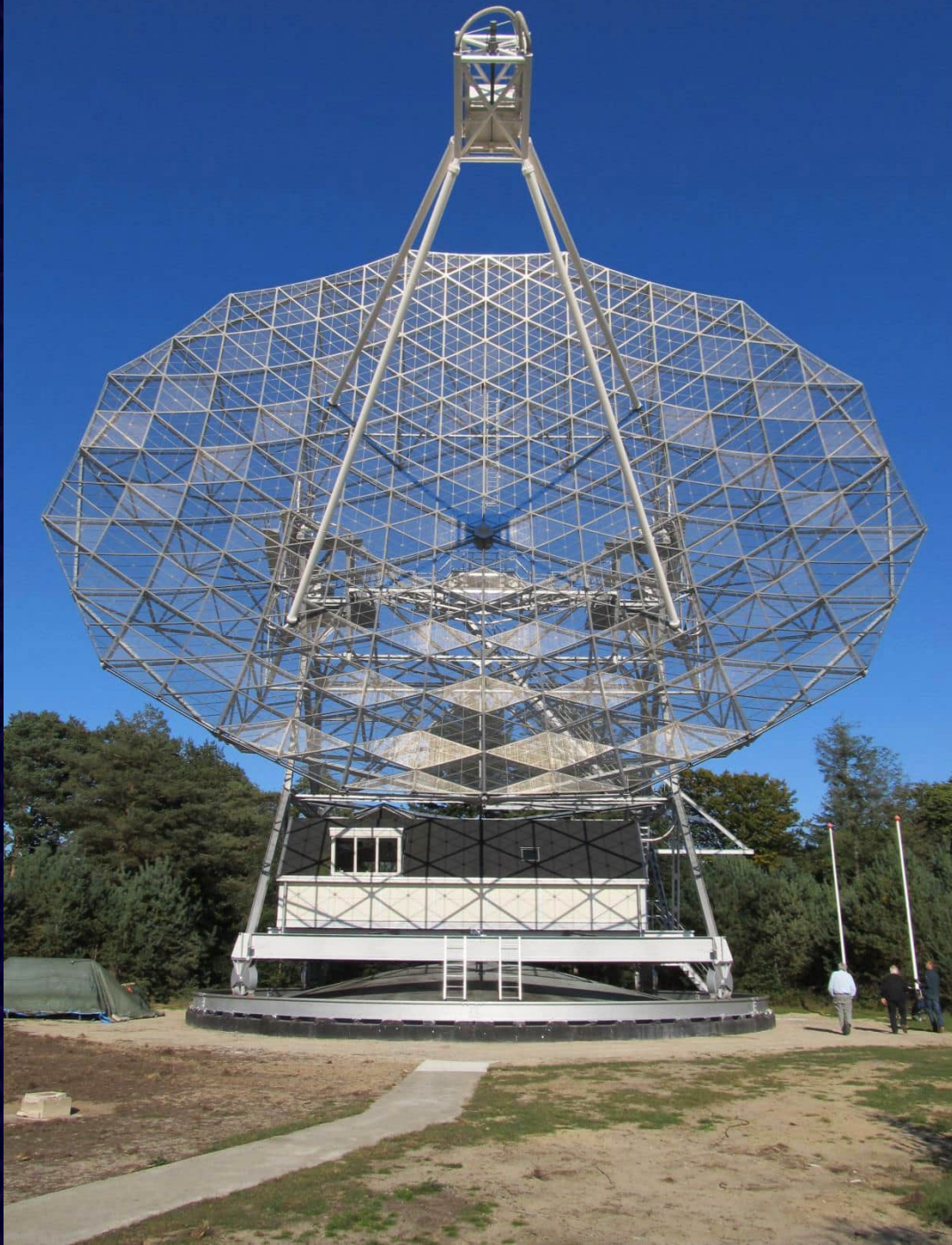









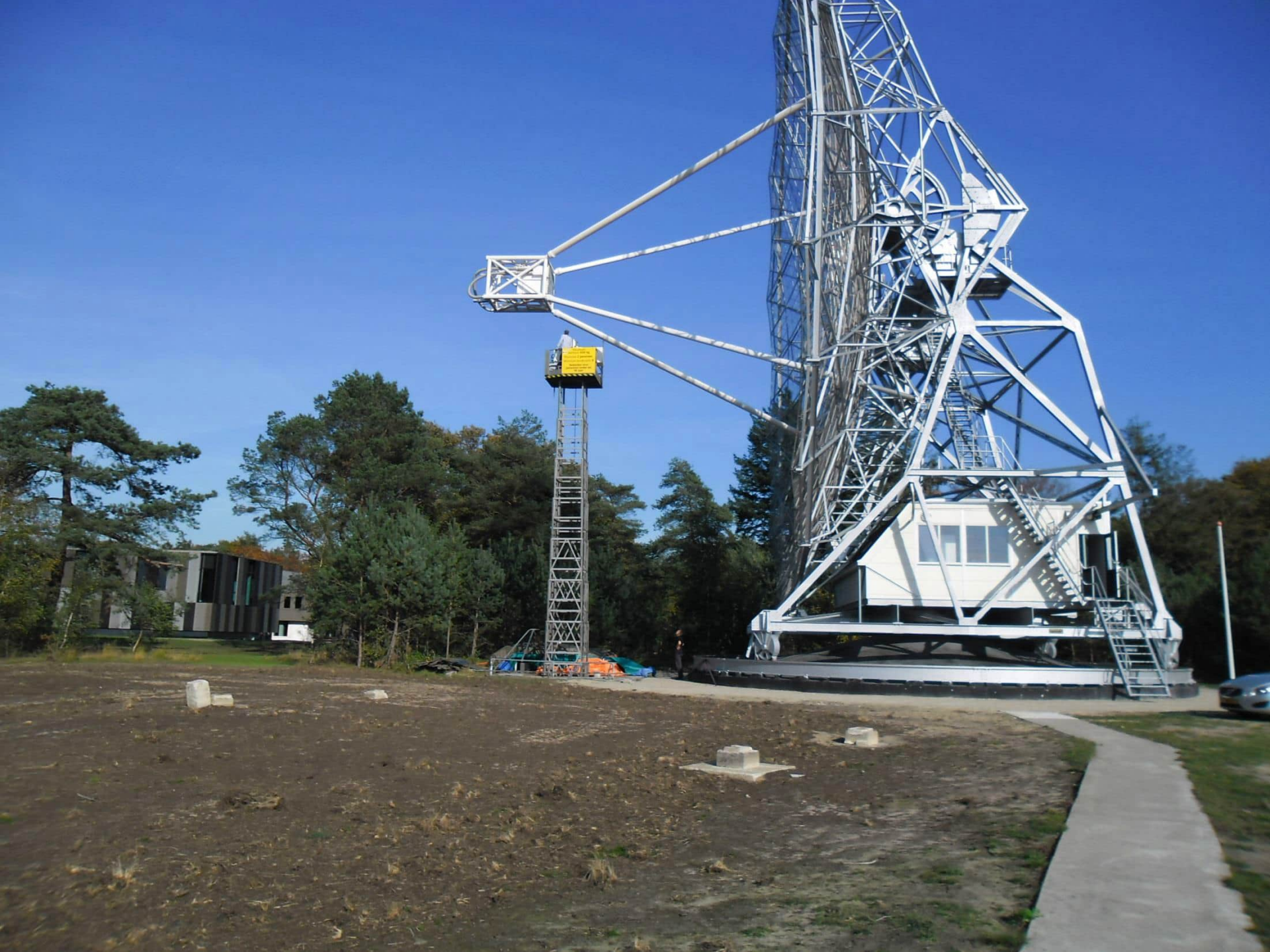



A low-angle photograph of a worker on a white service platform of a wind turbine. The worker is wearing a light blue shirt and dark trousers, seen from the back. The platform is surrounded by a complex network of white metal beams. A yellow safety sign with black text and a black and yellow striped border is attached to the platform. The background is a clear, bright blue sky.

Maximum  
werklast: 600 kg  
Maximaal 2 personen  
Maximum windkracht: 6  
Verboden voor  
personen onder de  
18 jaar

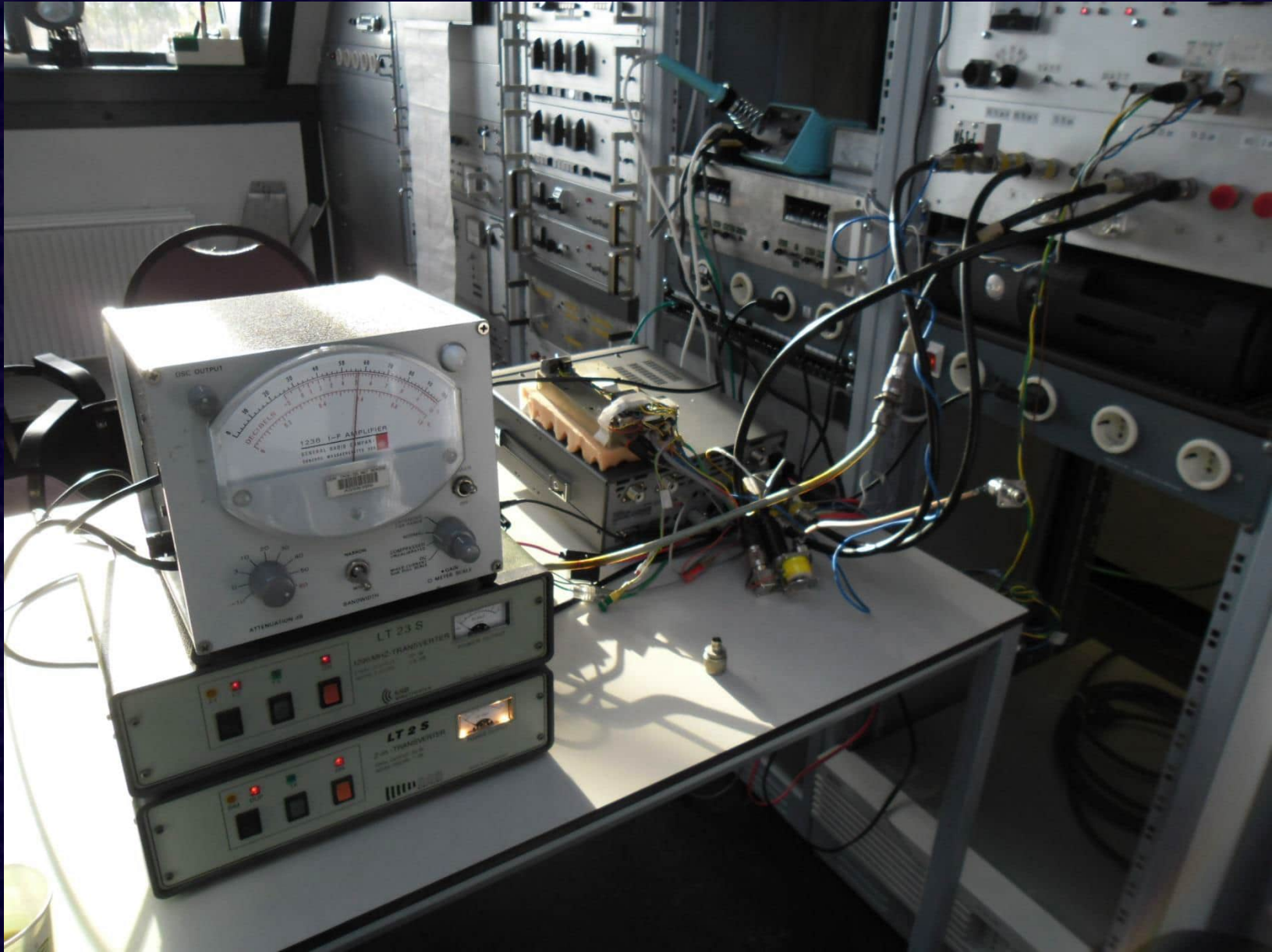



PI9CAM



Cor PEoSHF

Harry PE1CHQ

Theo PA3DDS

Jan PA3FXB

Eene PA3CEG









Windows XP Professional Edition  
Microsoft Corporation  
© 2005 Microsoft Corporation  
All rights reserved.  
This copy of the software and/or documentation may be used only on the computer system to which it is licensed.

Table with 4 columns and 10 rows of data.

1	2	3	4
1	2	3	4
5	6	7	8
9	10	11	12
13	14	15	16
17	18	19	20
21	22	23	24
25	26	27	28
29	30	31	32
33	34	35	36



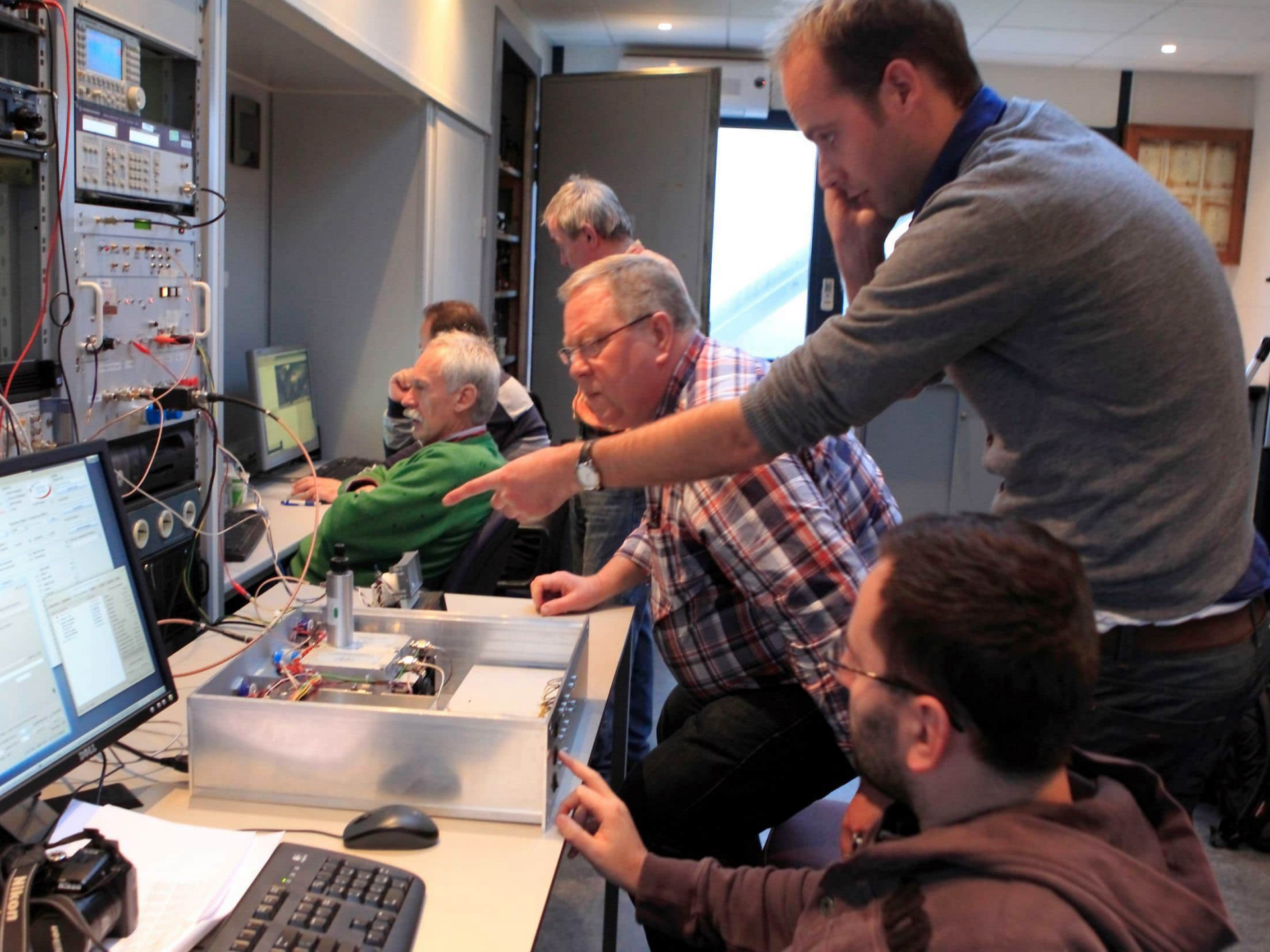



# A MOONBOUNCE WEDDING

## Valentine's Day 2014

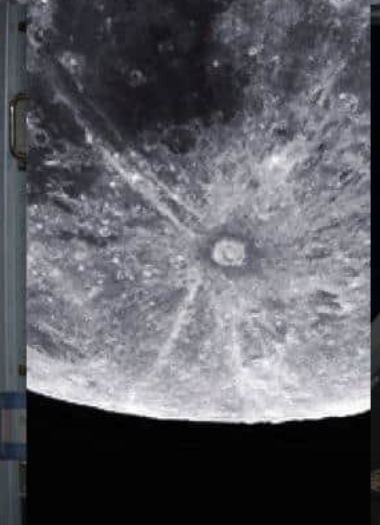







Joe Taylor  
was here!





# Stand van zaken sept 2024

- Meer dan 3600 EME QSO's
- Op 6 banden
- 29 firsts
- Heel veel satellieten/sondes ontvangen
- 4 satellieten gered
- 14 kunstenaars gefaciliteerd
- Veel radioastronomie (pulsar, waterstof, quasar, OH maser, etc)
- Veel rondleidingen

